



KETENCI®

SANAYİ VE TİCARET KOLL. ŞTİ.

56.yıl

FİYAT LİSTESİ

ŞUBAT 2023

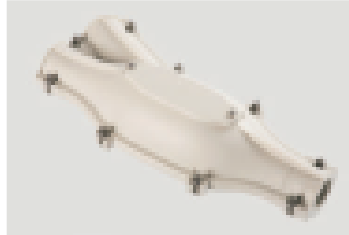
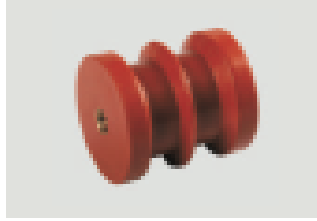
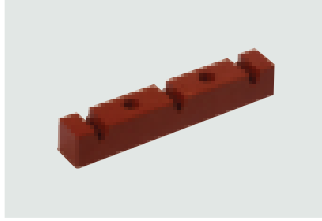
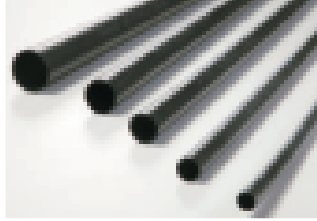
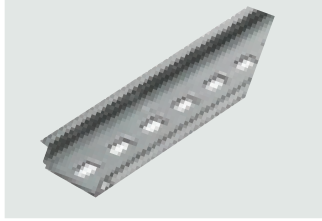
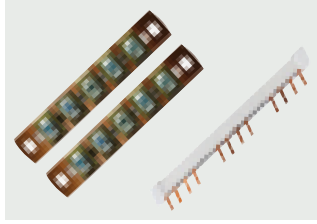
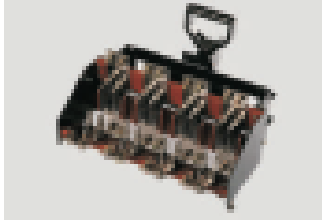



ENERJİYE YÖN VERİR



Ketenci San. Tic. ve Koll. Őti. 1967'de Sadettin Ketenci tarafından kurulmuŐtur. 1976'dan itibaren piyasadaki talepler dođrultusunda Őzengili Őalterler, İzalatörler ile Termo Plastik Kablo başlıkları ve Ek Mufları imal etmekte ve satıŐa sunmaktadır.

56 yıldır bu piyasada devamlılıđını sürdüren firmamız kendini sürekli yenileyerek ve Kalite Yönetim Sistemi hedefleri dođrultusunda geliŐtirerek müŐteri ihtiyacını ve memnuniyetini karŐılamaya çalıŐmaktadır.

KETENÇİ ÖZENGİLİ ŞALTERLER



ÖZENGİLİ ŞALTERLER (3 KONTAKLI)

KOD	TİP	ÜRÜN ADI	Derinlik	Yükseklik	Genişlik	Fiyat
01.101	KS. 101	200 Amper Özengili Şalter	180mm	140mm	134mm	2,250,00 TL.
01.102	KS. 102	250 Amper Özengili Şalter	240mm	190mm	205mm	2,500,00 TL.
01.103	KS. 103	400 Amper Özengili Şalter	280mm	253mm	230mm	3,750,00 TL.
01.104	KS. 104	630 Amper Özengili Şalter	280mm	253mm	230mm	5,000,00 TL.
01.105	KS. 105	1000 Amper Özengili Şalter	265mm	260mm	320mm	8,250,00 TL.
01.106	KS. 106	1500 Amper Özengili Şalter	270mm	270mm	384mm	11,000,00 TL.
01.107	KS. 107	2000 Amper Özengili Şalter	350mm	390mm	530mm	24,000,00 TL.
01.108	KS. 108	3000 Amper Özengili Şalter	350mm	390mm	530mm	35,000,00 TL.

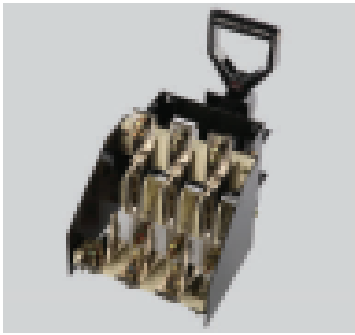

ÖZENGİLİ ENVERSÖR ŞALTERLER (3 KONTAKLI)

KOD	TİP	ÜRÜN ADI	Derinlik	Yükseklik	Genişlik	Fiyat
02.111	KS.111	200 Amper Özengili Enversör Şalter	223mm	140mm	138mm	3,000,00 TL.
02.112	KS.112	250 Amper Özengili Enversör Şalter	315mm	190mm	210mm	3,750,00 TL.
02.113	KS.113	400 Amper Özengili Enversör Şalter	365mm	253mm	240mm	5,500,00 TL.
02.114	KS.114	630 Amper Özengili Enversör Şalter	365mm	253mm	240mm	7,500,00 TL.
02.115	KS.115	1000 Amper Özengili Enversör Şalter	360mm	260mm	334mm	12,000,00 TL.
02.116	KS.116	1500 Amper Özengili Enversör Şalter	360mm	260mm	394mm	16,000,00 TL.
02.117	KS.117	2000 Amper Özengili Enversör Şalter	490mm	390mm	540mm	32,500,00 TL.
02.118	KS.118	3000 Amper Özengili Enversör Şalter	490mm	390mm	540mm	47,500,00 TL.

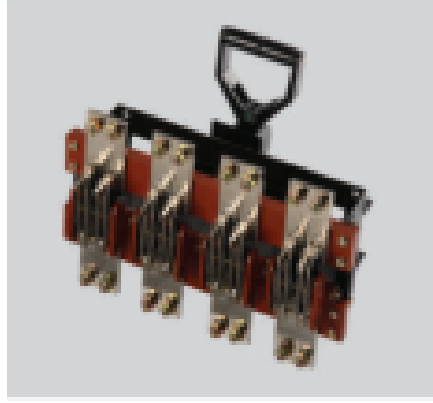

ÖZENGİLİ ŞALTERLER (4 KONTAKLI)

KOD	TİP	ÜRÜN ADI	Derinlik	Yükseklik	Genişlik	Fiyat
01.121	KS. 121	4X200 Amper Özengili Şalter	180mm	140mm	180mm	3,750,00 TL.
01.122	KS. 122	4X250 Amper Özengili Şalter	240mm	190mm	240mm	4,500,00 TL.
01.123	KS. 123	4X400 Amper Özengili Şalter	280mm	253mm	310mm	6,000,00 TL.
01.124	KS. 124	4X630 Amper Özengili Şalter	280mm	253mm	310mm	7,500,00 TL.
01.125	KS. 125	4X1000 Amper Özengili Şalter	265mm	260mm	420mm	13,500,00 TL.
01.126	KS. 126	4X1500 Amper Özengili Şalter	270mm	260mm	470mm	17,000,00 TL.



ÖZENGİLİ ENVERSÖR ŞALTERLER (4 KONTAKLI)

KOD	TİP	ÜRÜN ADI	Derinlik	Yükseklik	Genişlik	Fiyat
02.131	KS.131	4X200 Amper Özengili Enversör Şalter	223mm	140mm	180mm	5,000,00 TL.
02.132	KS.132	4X250 Amper Özengili Enversör Şalter	315mm	190mm	240mm	6,000,00 TL.
02.133	KS.133	4X400 Amper Özengili Enversör Şalter	365mm	253mm	310mm	8,000,00 TL.
02.134	KS.134	4X630 Amper Özengili Enversör Şalter	365mm	253mm	310mm	11,000,00 TL.
02.135	KS.135	4X1000 Amper Özengili Enversör Şalter	360mm	260mm	420mm	18,500,00 TL.
02.136	KS.136	4X1500 Amper Özengili Enversör Şalter	360mm	260mm	470mm	22,500,00 TL.

BARA MESNET İZOLATÖRLERİ

BM 11

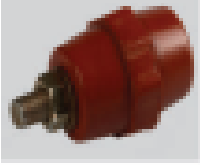

BM 11/A

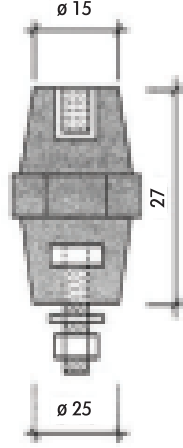

MİNİ İZOLATÖR

KOD	ÜRÜN ADI	KUTU AD.	KOLİ AD.	FİYAT
05.010	BM 11/A (M5 2C)	100	1500	8,25 TL.
05.009	BM 11 (M5 1C 1S)	100	1500	10,00 TL.
05.023	BM 10 (M5 2S)	100	1500	12,50 TL.

BM 12

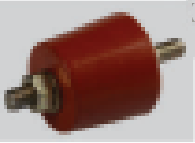
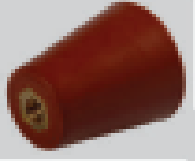

BM 14

BM 13

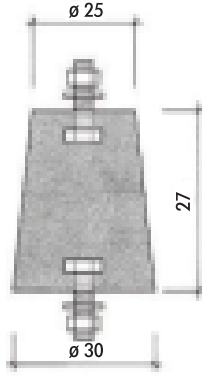

ORTA BOY İZOLATÖR

KOD	ÜRÜN ADI	KUTU AD.	KOLİ AD.	FİYAT
05.012	BM 14 (M6 2C)	100	500	11,50 TL.
05.018	BM 13 (M6 1C 1S)	100	500	12,50 TL.
05.011	BM 12 (M6 2S)	80	500	14,50 TL.

BM 4

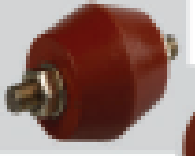

BM 5

BM 5/A

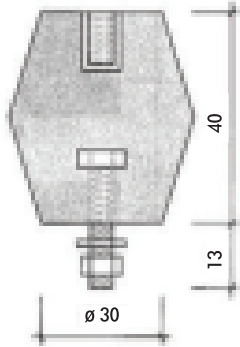
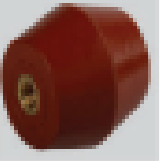

BÜYÜK BOY İZOLATÖR

KOD	ÜRÜN ADI	KUTU AD.	KOLİ AD.	FİYAT
05.003	BM 4 (M8 2C)	50	250	19,00 TL.
05.004	BM 5 (M8 1C 1S)	50	250	20,50 TL.
05.005	BM 5/A (M8 2S)	50	250	22,00 TL.

BM 6/A

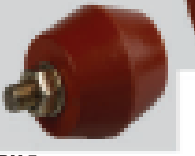
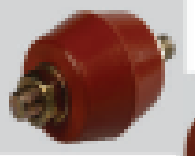

BM 7

BM 6

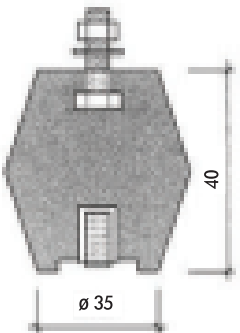
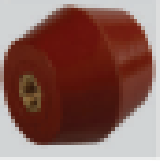

BÜYÜK BOY İZOLATÖR

KOD	ÜRÜN ADI	KUTU AD.	KOLİ AD.	FİYAT
05.007	BM 6/A (M10 2C)	40	200	27,00 TL.
05.008	BM 7 (M10 1C 1S)	40	200	28,50 TL.
05.006	BM 6 (M10 2S)	50	250	30,00 TL.

BARA MESNET İZOLATÖRLERİ

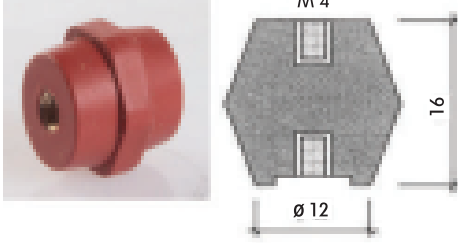
BM 1

MİNİ İZOLATÖR

KOD	ÜRÜN ADI	KUTU AD.	KOLİ AD.	FİYAT
05.017	BM 1 (M4 2S)	250	1000	17,50 TL.

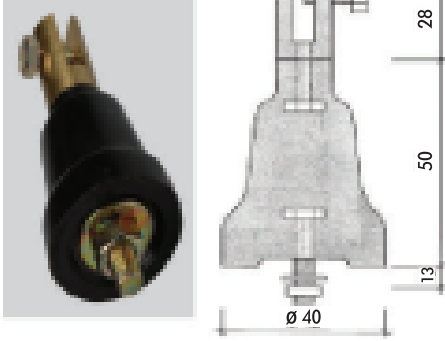
BM 2

PİRİNÇ SERFİLLİ İZOLATÖR

KOD	ÜRÜN ADI	KUTU AD.	KOLİ AD.	FİYAT
05.001	BM 2 (M8 PİRİNÇ SERFİLLİ)	50	300	70,00 TL.

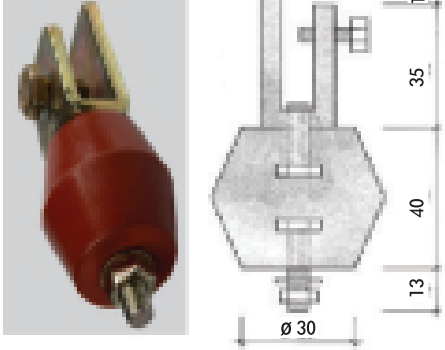
BM 3

ÇELİK SERFİLLİ İZOLATÖR

KOD	ÜRÜN ADI	KUTU AD.	KOLİ AD.	FİYAT
05.002	BM 3 (M8 ÇELİK SERFİLLİ)	30	150	50,00 TL.

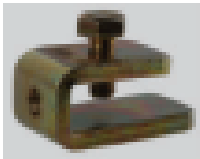
M 8

M 10

SERFİLLER

KOD	ÜRÜN ADI	KUTU AD.	KOLİ AD.	FİYAT
05.020	M8 ÇELİK SERFİL	100	500	20,00 TL.
05.021	M10 ÇELİK SERFİL	100	500	21,50 TL.

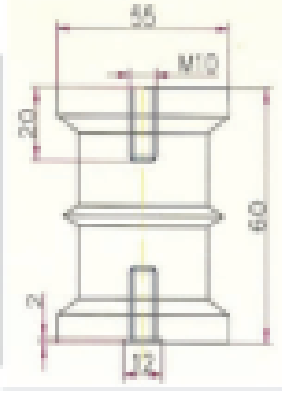
BARA MESNET İZOLATÖRLERİ



1N 500 İZOLATÖR

KOD	ÜRÜN ADI	KUTU AD.	FİYAT
05.016	1 N 500 (M 8 2S)	80	42,50 TL.
05.013	1 N 500 (M 10 2S)	80	50,00 TL.
05.014	1 N 500 (M 12 2S)	80	55,00 TL.

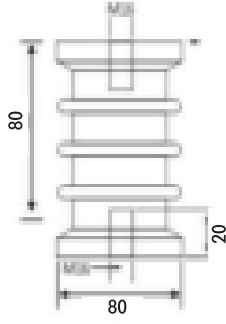

1N 1000 İZOLATÖR

KOD	ÜRÜN ADI	KUTU AD.	FİYAT
05.037	1 N 1000 (M 12 2S)	36	Fiyat sorunuz
05.038	1 N 1000 (M 16 2S)	36	Fiyat sorunuz

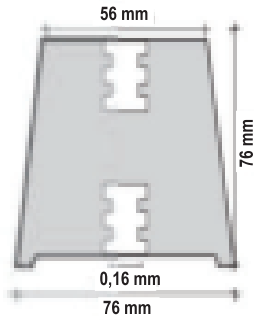

1NK İZOLATÖR

KOD	ÜRÜN ADI	KUTU AD.	FİYAT
05.015	1 NK (M 16 2S)	36	80,00 TL.

TARAK İZOLATÖRLERİ



3 X 1F

KOD	ÜRÜN ADI	KUTU AD.	FİYAT
05.031	3 X 1F Tarak İzolatör	60	27,50 TL.

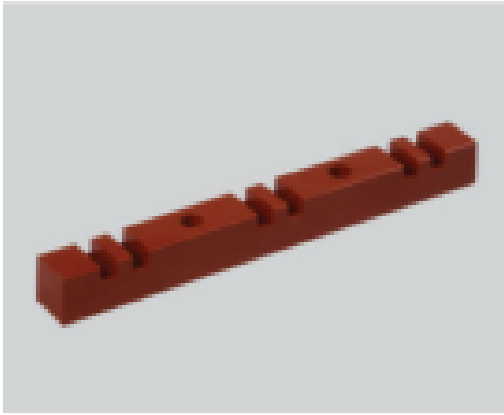
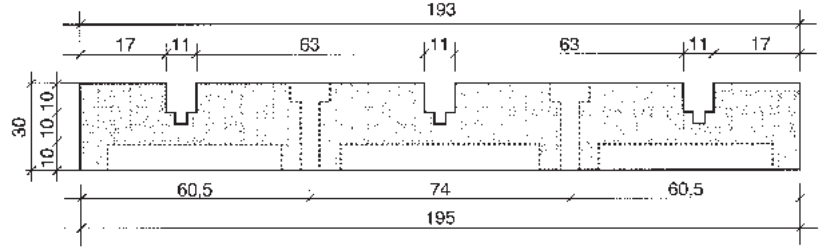

3 x 2F

KOD	ÜRÜN ADI	KUTU AD.	FİYAT
05.032	3 X 2F Tarak İzolatör	48	36,50 TL.

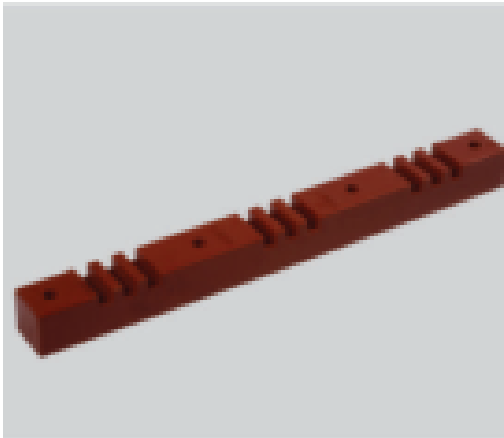
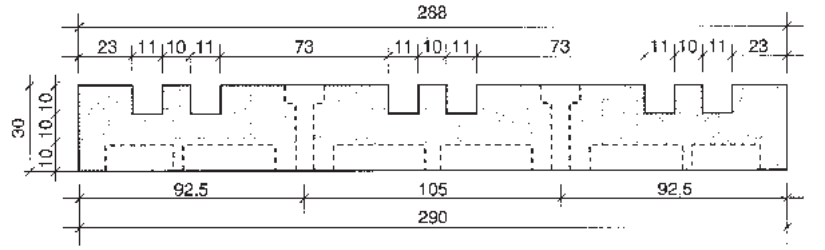

3 x 3F

KOD	ÜRÜN ADI	KUTU AD.	FİYAT
05.033	3 X 3F Tarak İzolatör	36	150,00 TL.

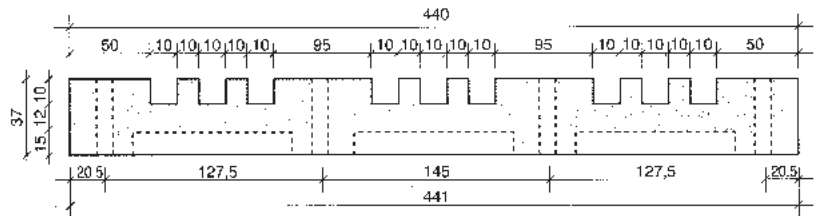

TARAK İZOLATÖRLERİ

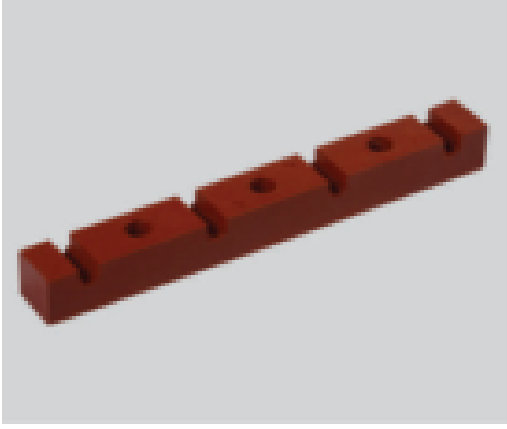

3 X 1F + N - (1 X 4F)

KOD	ÜRÜN ADI	KUTU AD.	FİYAT
05.034	3 X 1F+N Tarak İzolatör	30	37,50 TL.

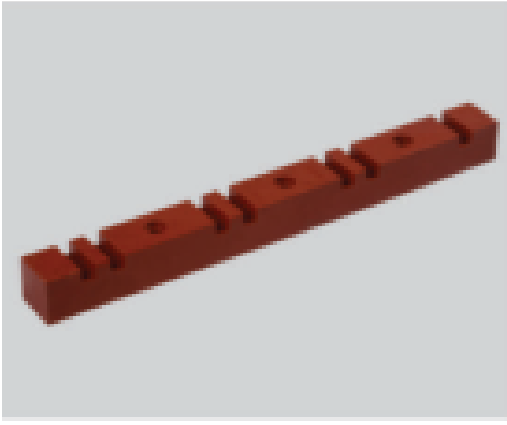
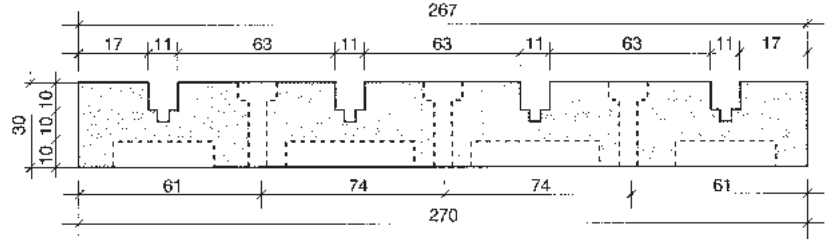

3 x 2F + N

KOD	ÜRÜN ADI	KUTU AD.	FİYAT
05.035	3 X 2F+N Tarak İzolatör	30	49,00 TL.

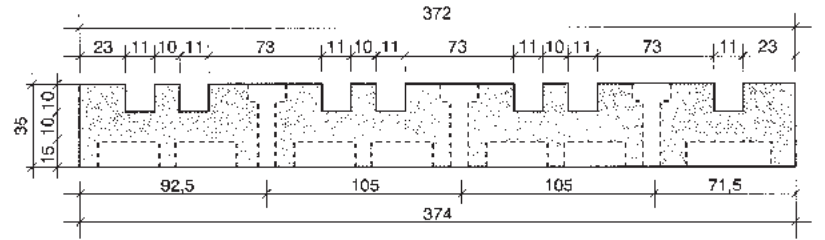

TERMO PLASTİK REÇİNELİ EK MUFLARI 1kV

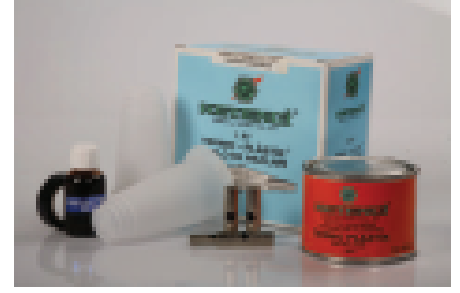

REÇİNELİ EK MUFLAR 1kV STANDART BAKIR KABLOLAR İÇİN

KOD	TİP	KABLO KESİTİ	FİYAT
07.001	EM 1	4 x 2,5 mm ²	210,00 TL.
07.002	EM 2	4 x 4 mm ²	210,00 TL.
07.003	EM 3	4 x 6 mm ²	210,00 TL.
07.004	EM 4	4 x 10 mm ²	315,00 TL.
07.005/A	EM 5/A	4 x 16 mm ²	325,00 TL.
07.005	EM 5	3 x16 +10 mm ²	325,00 TL.
07.006	EM 6	3 x 25 +16 mm ²	335,00 TL.
07.007	EM 7	3 x 35 +16 mm ²	345,00 TL.
07.008	EM 8	3 x 50 +25 mm ²	450,00 TL.
07.009	EM 9	3 x 70 +35 mm ²	525,00 TL.
07.010	EM 10	3 x 95 +50 mm ²	575,00 TL.
07.011	EM 11	3 x 120 +70 mm ²	900,00 TL.
07.012	EM 12	3 x 150 +70 mm ²	1,000,00 TL.
07.013	EM 13	3 x 185 +95 mm ²	1,450,00 TL.
07.014	EM 14	3 x 240 +120 mm ²	1,650,00 TL.

REÇİNELİ EK MUFLAR 1kV ÇELİK ZIRHLI BAKIR KABLOLAR (NYFGbY) İÇİN

KOD	KABLO KESİTİ	FİYAT
09.001	4 x 10 mm ²	380,00 TL.
09.002	4 x 16 mm ²	390,00 TL.
09.002/A	3 x16 +10 mm ²	390,00 TL.
09.003	3 x 25 +16 mm ²	400,00 TL.
09.004	3 x 35 +16 mm ²	410,00 TL.
09.005	3 x 50 +25 mm ²	550,00 TL.
09.006	3 x 70 +35 mm ²	625,00 TL.
09.007	3 x 95 +50 mm ²	675,00 TL.
09.008	3 x 120 +70 mm ²	1,050,00 TL.
09.009	3 x 150 +70 mm ²	1,150,00 TL.
09.010	3 x 185 +95 mm ²	1,650,00 TL.
09.011	3 x 240 +120 mm ²	1,850,00 TL.

TERMO PLASTİK REÇİNELİ EK MUFLARI 1kV



KABLO BAŞLIKLARI 1kV

KOD	KABLO KESİTİ	FİYAT
06.001	No.1 4 x 10'dan - 4 x 2,5 mm ²	120,00 TL.
06.002	No.2 4 x 35'den - 4 x 70 mm ²	150,00 TL.
06.003	No.3 4 x 95'den - 4 x 150 mm ²	190,00 TL.
06.004	No.4 4 x 185'den - 4 x 240 mm ²	230,00 TL.

EK MUFLARI 1 kV TEK DAMARLI BAKIR KABLolar İÇİN

KOD	KABLO KESİTİ	FİYAT
08.001	1 x 10 mm ²	185,00 TL.
08.002	1 x 16 mm ²	190,00 TL.
08.003	1 x 25 mm ²	195,00 TL.
08.004	1 x 35 mm ²	200,00 TL.
08.005	1 x 50 mm ²	235,00 TL.
08.006	1 x 70 mm ²	245,00 TL.
08.007	1 x 95 mm ²	255,00 TL.
08.008	1 x 120 mm ²	320,00 TL.
08.009	1 x 150 mm ²	340,00 TL.
08.010	1 x 185 mm ²	425,00 TL.
08.011	1 x 240 mm ²	445,00 TL.

TERMO PLASTİK REÇİNELİ EK MUFLARI 1kV



REÇİNELİ EK MUFLAR 1 kV ALÜMİNYUM KABLolar İÇİN

KOD	KABLO KESİTİ	FİYAT
07.105	4 x 16 mm ²	325,00 TL.
07.106	3 x 25 + 16 mm ²	340,00 TL.
07.107	3 x 35 + 16 mm ²	355,00 TL.
07.108	3 x 50 + 25 mm ²	450,00 TL.
07.109	3 x 70 + 35 mm ²	500,00 TL.
07.110	3 x 95 + 50 mm ²	550,00 TL.
07.111	3 x 120 + 70 mm ²	900,00 TL.
07.112	3 x 150 + 70 mm ²	975,00 TL.
07.113	3 x 185 + 95 mm ²	1,400,00 TL.
07.114	3 x 240 + 120 mm ²	1,500,00 TL.

EK MUFLAR 1 kV TEK DAMARLI ALÜMİNYUM KABLolar İÇİN

KOD	KABLO KESİTİ	FİYAT
08.102	1 x 16 mm ²	200,00 TL.
08.103	1 x 25 mm ²	210,00 TL.
08.104	1 x 35 mm ²	220,00 TL.
08.105	1 x 50 mm ²	275,00 TL.
08.106	1 x 70 mm ²	300,00 TL.
08.107	1 x 95 mm ²	325,00 TL.
08.108	1 x 120 mm ²	375,00 TL.
08.109	1 x 150 mm ²	400,00 TL.
08.110	1 x 185 mm ²	475,00 TL.
08.112	1 x 240 mm ²	500,00 TL.

YENİDEN DOLDURULABİLİR EK MUFLARI

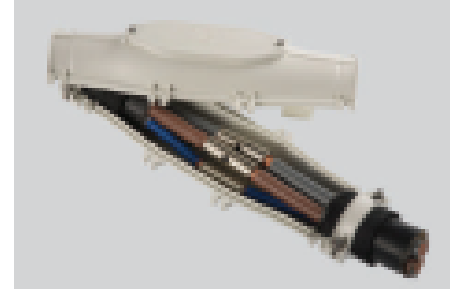

DÜZ TİP GİRİŞ - ÇIKIŞ YENİDEN DOLDURULABİLİR EKMUUF (BEDAŞ TİPİ)

ÜRÜN ADI	KABLO KESİTİ	SADECE KALIP (B)		KALIP İLAÇ (A)		KALIP İLAÇ MUUF (C)	
		KOD	FİYAT	KOD	FİYAT	KOD	FİYAT
DM1 YEDO/ EK MUUFU	4X2,5	15.101	340,00 TL.	15.001	565,00 TL.	15.201	640,00 TL.
DM1 YEDO/ EK MUUFU	4X4	15.102	340,00 TL.	15.002	565,00 TL.	15.202	640,00 TL.
DM1 YEDO/ EK MUUFU	4X6	15.103	340,00 TL.	15.003	565,00 TL.	15.203	640,00 TL.
DM2 YEDO/ EK MUUFU	4X10	15.104	415,00 TL.	15.004	675,00 TL.	15.204	750,00 TL.
DM2/2 YEDO/ EK MUUFU	4X16 (3X16+10)	15.108	450,00 TL.	15.008	790,00 TL.	15.208	865,00 TL.
DM2/2 YEDO/ EK MUUFU	3X25+16	15.109	450,00 TL.	15.009	790,00 TL.	15.209	865,00 TL.
DM3 YEDO/ EK MUUFU	3X35+16	15.110	465,00 TL.	15.010	940,00 TL.	15.210	1,100,00 TL.
DM3 YEDO/ EK MUUFU	3X50+25	15.111	465,00 TL.	15.011	940,00 TL.	15.211	1,100,00 TL.
DM3 YEDO/ EK MUUFU	3X70+35	15.112	465,00 TL.	15.012	940,00 TL.	15.212	1,100,00 TL.
DM4/1 YEDO/ EK MUUFU	3X95+50	15.113	660,00 TL.	15.013	1,200,00 TL.	15.213	1,400,00 TL.
DM4/3 YEDO/ EK MUUFU	3X120+70	15.117	750,00 TL.	15.017	1,725,00 TL.	15.217	2,000,00 TL.
DM4/3 YEDO/ EK MUUFU	3X150+70	15.118	750,00 TL.	15.018	1,725,00 TL.	15.218	2,000,00 TL.
DM5 YEDO/ EK MUUFU	3X185+95	15.119	825,00 TL.	15.019	1,875,00 TL.	15.219	2,250,00 TL.
DM5 YEDO/ EK MUUFU	3X240+120	15.120	825,00 TL.	15.020	1,875,00 TL.	15.220	2,250,00 TL.

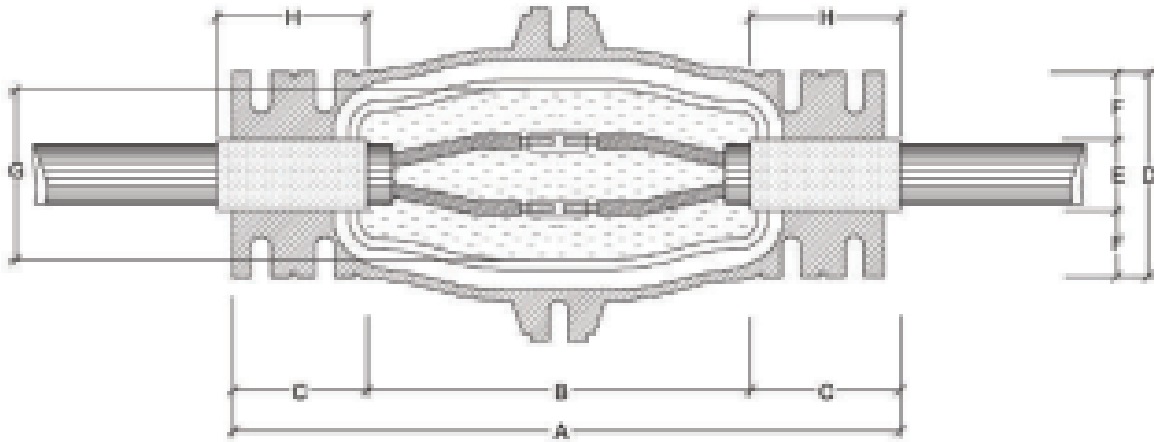

	KABLO mm ²	A	B	C	D	E	F	G	BAND H	VIDA mm	YEDOFLEX
DM.1	2,5-4-6	204	120	42	58	22	18	50	50	6	300 gr
DM.2	10	264	180	42	67	31	18	60	50	6	600 gr
DM.2/2	10-16-25	310	206	52	67	31	18	90	60	6	1400 gr
DM.3	35-50-70	354	250	52	87	43	22	80	60	8	1400 gr
DM.4/3	95-120-150	550	410	70	99	55	22	125	80	8	4250 gr
DM.4	95	426	310	58	99	55	22	90	70	8	2250 gr
DM.5	185-240	496	380	58	114	70	22	100	70	8	4250 gr

YENİDEN DOLDURULABİLİR EK MUFLARI



Y TİP BRANŞMANLI YENİDEN DOLDURULABİLİR EKMUUF (BEDAŞ TİPİ)

ÜRÜN ADI	KABLO KESİTİ	SADECE KALIP (B)		KALIP İLAÇ (A)		KALIP İLAÇ MUF (C)	
		KOD	FİYAT	KOD	FİYAT	KOD	FİYAT
YM1 YEDO/ EK MUFU	4X2,5	15.121	425,00 TL.	15.021	650,00 TL.	15.221	800,00 TL.
YM1 YEDO/ EK MUFU	4X4	15.122	425,00 TL.	15.022	650,00 TL.	15.222	800,00 TL.
YM1 YEDO/ EK MUFU	4X6	15.123	425,00 TL.	15.023	650,00 TL.	15.223	800,00 TL.
YM2 YEDO/ EK MUFU	4X10	15.124	525,00 TL.	15.024	900,00 TL.	15.224	1,100,00 TL.
YM2 YEDO/ EK MUFU	4X16 (3X16+10)	15.125	525,00 TL.	15.025	900,00 TL.	15.225	1,100,00 TL.
YM2 YEDO/ EK MUFU	3X25+16	15.126	525,00 TL.	15.026	900,00 TL.	15.226	1,100,00 TL.
YM3 YEDO/ EK MUFU	3X35+16	15.127	675,00 TL.	15.027	1,250,00 TL.	15.227	1,650,00 TL.
YM3 YEDO/ EK MUFU	3X50+25	15.128	675,00 TL.	15.028	1,250,00 TL.	15.228	1,650,00 TL.
YM3 YEDO/ EK MUFU	3X70+35	15.129	675,00 TL.	15.029	1,250,00 TL.	15.229	1,650,00 TL.
YM4/1 YEDO/ EK MUFU	3X95+50	15.130	825,00 TL.	15.030	1,950,00 TL.	15.230	2,500,00 TL.
YM4/1 YEDO/ EK MUFU	3X120+70	15.131	825,00 TL.	15.031	1,950,00 TL.	15.231	2,500,00 TL.
YM4/1 YEDO/ EK MUFU	3X150+70	15.132	825,00 TL.	15.032	1,950,00 TL.	15.232	2,500,00 TL.
YM5 YEDO/ EK MUFU	3X185+95	15.133	1,125,00 TL.	15.033	3,400,00 TL.	15.233	4,250,00 TL.
YM5 YEDO/ EK MUFU	3X240+120	15.134	1,125,00 TL.	15.034	3,400,00 TL.	15.234	4,250,00 TL.

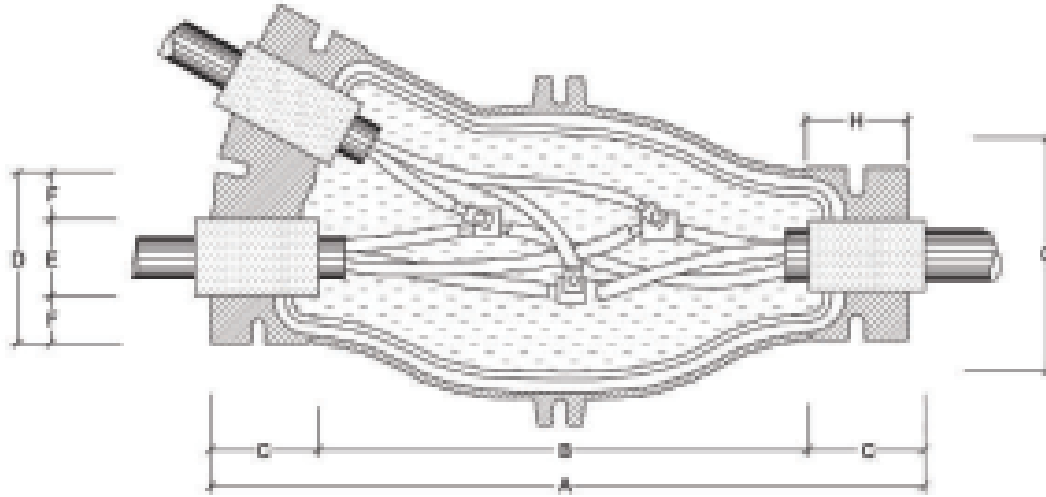

	KABLO mm ²	A	B	C	D	E	F	G	BAND H	VIDA mm	YEDOFLEX
YM.1	2,5-4-6	244	160	42	58	22	18	70	50	6	600 gr
YM.2	10-16-25	324	240	42	67	31	18	100	50	6	1400 gr
YM.3	35-50-70	454	350	52	87	43	22	120	60	8	3500 gr
YM.4/1	95-120-150	490	400	45	97	55	22	150	70	8	5500 gr
YM.5	150-185-240	596	480	58	114	70	22	160	70	8	10500 gr

YENİDEN DOLDURULABİLİR EK MUFLARI



T TİP BRANŞMANLI YENİDEN DOLDURULABİLİR EKMUFLAR (BEDAŞ TİPİ)

ÜRÜN ADI	KABLO KESİTİ	SADECE KALIP (B)		KALIP İLAÇ (A)		KALIP İLAÇ MUFLAR (C)	
		KOD	FİYAT	KOD	FİYAT	KOD	FİYAT
TM 2 YEDO/ EK MUFLAR	4X10	15.135	500,00 TL.	15.035	1,050,00 TL.	15.235	1,200,00 TL.
TM 2 YEDO/ EK MUFLAR	4X16 (3X16+10)	15.136	500,00 TL.	15.036	1,050,00 TL.	15.236	1,200,00 TL.
TM 2 YEDO/ EK MUFLAR	3X25+16	15.137	500,00 TL.	15.037	1,050,00 TL.	15.237	1,200,00 TL.
TM 3 YEDO/ EK MUFLAR	3X35+16	15.138	750,00 TL.	15.038	1,500,00 TL.	15.238	1,750,00 TL.
TM 3 YEDO/ EK MUFLAR	3X50+25	15.139	750,00 TL.	15.039	1,500,00 TL.	15.239	1,750,00 TL.
TM 3 YEDO/ EK MUFLAR	3X70+35	15.140	750,00 TL.	15.040	1,500,00 TL.	15.240	1,750,00 TL.
TM 4 YEDO/ EK MUFLAR	3X95+50	15.141	1,000,00 TL.	15.041	2,250,00 TL.	15.241	2,750,00 TL.
TM 4 YEDO/ EK MUFLAR	3X120+70	15.142	1,000,00 TL.	15.042	2,250,00 TL.	15.242	2,750,00 TL.
TM 4 YEDO/ EK MUFLAR	3X150+70	15.143	1,000,00 TL.	15.043	2,250,00 TL.	15.243	2,750,00 TL.
TM 5 YEDO/ EK MUFLAR	3X185+95	15.144	1,500,00 TL.	15.044	4,250,00 TL.	15.244	5,500,00 TL.
TM 5 YEDO/ EK MUFLAR	3X240+120	15.145	1,500,00 TL.	15.045	4,250,00 TL.	15.245	5,500,00 TL.

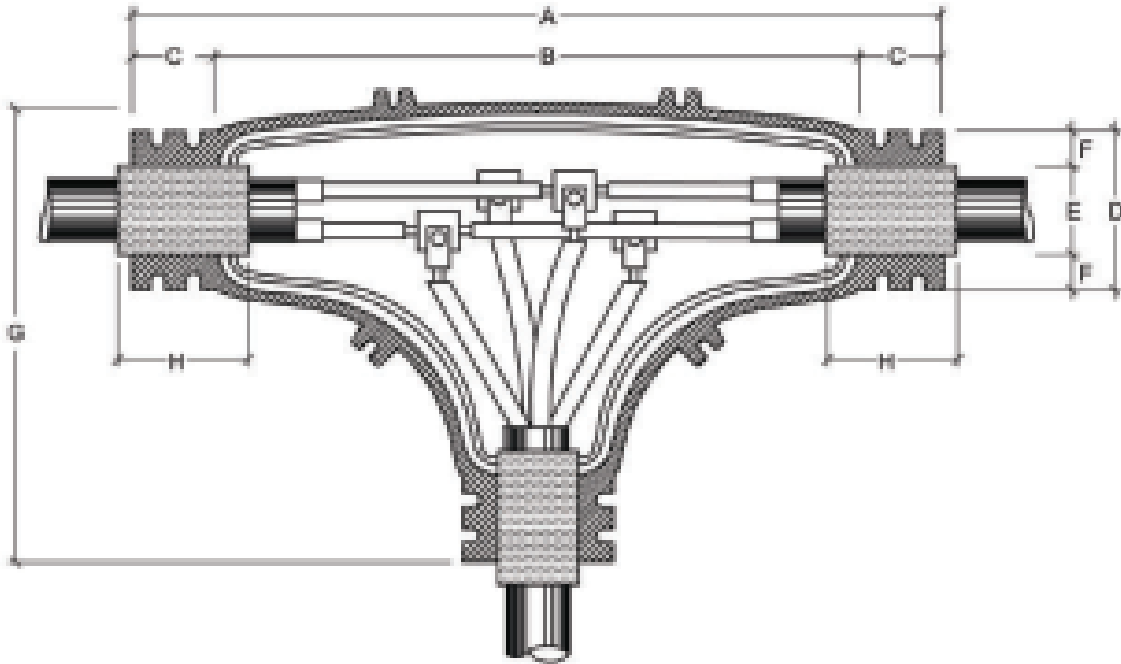

	KABLO mm ²	A	B	C	D	E	F	G	BAND H	VIDA mm	YEDOFLEX
YM.2	10-16-25	324	220	52	71	31	20	210	50	M6	1400 gr
YM.3	35-50-70	324	220	52	71	31	20	210	50	M6	3750 gr
YM.4	95-120-150	544	400	72	103	55	24	349	90	M8	7500 gr
YM.5	185-240	664	500	82	118	70	24	427	100	M8	17500 gr

DOLGU DÖKÜM MALZEMELERİ (PROTOLİN REÇİNE)



TERMO-PLASTİK DOLGU MALZEMELERİ 1kV REÇİNE / PROTOLİN

KOD	ÜRÜN	FİYAT
10.005	100 gr Ana Malzeme ve Sertleştirici	62,00 TL.
10.004	300 gr Ana Malzeme ve Sertleştirici	100,00 TL.
10.004/A	400 gr Ana Malzeme ve Sertleştirici	120,00 TL.
10.003	500 gr Ana Malzeme ve Sertleştirici	130,00 TL.
10.001	1000 gr Ana Malzeme ve Sertleştirici	240,00 TL.
10.006	5000 gr Ana Malzeme ve Sertleştirici	1,100,00 TL.



YEDOFLEX DOLGU MALZEMELERİ YENİDEN DOLDURULABİLİR / YEDO EKMUF

KOD	ÜRÜN	FİYAT
16.302	1200 gr Ana Malzeme ve Sertleştirici	375,00 TL.
16.303	1400 gr Ana Malzeme ve Sertleştirici	415,00 TL.
16.305	3500 gr Ana Malzeme ve Sertleştirici	900,00 TL.
16.306	3750 gr Ana Malzeme ve Sertleştirici	975,00 TL.
16.307	4250 gr Ana Malzeme ve Sertleştirici	1,050,00 TL.
16.308	5500 gr Ana Malzeme ve Sertleştirici	1,150,00 TL.

BAKIR İLETKENLİ ISI BÜZÜŞMELİ EKMUFLAR 1kV



ISI BÜZÜŞMELİ EKMUFLAR 1kV STANDART TİP BAKIR KABLolar İÇİN

KOD	KESİT	FİYAT
12.002	4 x 2,5 mm ²	90,00 TL.
12.003	4 x 4 mm ²	90,00 TL.
12.004	4 x 6 mm ²	90,00 TL.
12.005	4 x 10 mm ²	115,00 TL.
12.006	4 x 16 mm ²	120,00 TL.
12.007	3 x 16 + 10 mm ²	120,00 TL.
12.008	3 x 25 + 16 mm ²	175,00 TL.
12.009	3 x 35 + 16 mm ²	190,00 TL.
12.010	3 x 50 + 25 mm ²	225,00 TL.
12.011	3 x 70 + 35 mm ²	300,00 TL.
12.012	3 x 95 + 50 mm ²	425,00 TL.
12.013	3 x 120 + 70 mm ²	475,00 TL.
12.014	3 x 150 + 70 mm ²	550,00 TL.
12.015	3 x 185 + 95 mm ²	850,00 TL.
12.016	3 x 240 + 120 mm ²	950,00 TL.

ISI BÜZÜŞMELİ EKMUFLAR 1kV UZUN (BEDAŞ) TİP BAKIR KABLolar İÇİN

KOD	KESİT	BOY	FİYAT
12.201	4 x 6 mm ²	30 cm	150,00 TL.
12.202	4 x 10 mm ²	40 cm	175,00 TL.
12.203	4 x 16 mm ²	50 cm	210,00 TL.
12.204	3 x 16 + 10 mm ²	50 cm	210,00 TL.
12.205	3 x 25 + 16 mm ²	50 cm	275,00 TL.
12.206	3 x 35 + 16 mm ²	50 cm	300,00 TL.
12.207	3 x 50 + 25 mm ²	60 cm	375,00 TL.
12.208	3 x 70 + 35 mm ²	60 cm	500,00 TL.
12.209	3 x 95 + 50 mm ²	60 cm	625,00 TL.
12.210	3 x 120 + 70 mm ²	70 cm	685,00 TL.
12.211	3 x 150 + 70 mm ²	70 cm	780,00 TL.
12.212	3 x 185 + 95 mm ²	90 cm	1,100,00 TL.
12.213	3 x 240 + 120 mm ²	90 cm	1,250,00 TL.

BAKIR KABLOLAR İÇİN ISI BÜZÜŞMELİ EK MUFLAR



ÇELİK ZIRHLI BAKIR KABLOLAR İÇİN 1kV STANDART TİP

KOD	KESİT	FİYAT
12.101	4 x 2,5 mm ²	120,00 TL.
12.102	4 x 4 mm ²	120,00 TL.
12.103	4 x 6 mm ²	120,00 TL.
12.104	4 x 10 mm ²	175,00 TL.
12.105	4 x 16 mm ²	180,00 TL.
12.105/A	3 x16 +10 mm ²	180,00 TL.
12.106	3 x 25 +16 mm ²	240,00 TL.
12.107	3 x 35 +16 mm ²	250,00 TL.
12.108	3 x 50 +25 mm ²	290,00 TL.
12.109	3 x 70 +35 mm ²	370,00 TL.
12.110	3 x 95 +50 mm ²	500,00 TL.
12.111	3 x 120 +70 mm ²	550,00 TL.
12.112	3 x 150 +70 mm ²	625,00 TL.
12.113	3 x 185 +95 mm ²	1,000,00 TL.
12.114	3 x 240 +120 mm ²	1,100,00 TL.

ÇELİK ZIRHLI BAKIR KABLOLAR İÇİN 1kV UZUN (BEDAŞ) TİP

KOD	KESİT	BOY	FİYAT
12.301	4 x 6 mm ²	30 cm	200,00 TL.
12.302	4 x 10 mm ²	40 cm	265,00 TL.
12.303	4 x 16 mm ²	50 cm	315,00 TL.
12.304	3 x16 +10 mm ²	50 cm	315,00 TL.
12.305	3 x 25 +16 mm ²	50 cm	375,00 TL.
12.306	3 x 35 +16 mm ²	50 cm	400,00 TL.
12.307	3 x 50 +25 mm ²	60 cm	500,00 TL.
12.308	3 x 70 +35 mm ²	60 cm	625,00 TL.
12.309	3 x 95 +50 mm ²	60 cm	750,00 TL.
12.310	3 x 120 +70 mm ²	70 cm	875,00 TL.
12.311	3 x 150 +70 mm ²	70 cm	975,00 TL.
12.312	3 x 185 +95 mm ²	90 cm	1,250,00 TL.
12.313	3 x 240 +120 mm ²	90 cm	1,400,00 TL.

BAKIR İLETKENLİ ÖZEL TİP ISI BÜZÜŞMELİ EK MUFLAR



ÖZEL ISI BÜZÜŞMELİ EK MUFLAR 1kV STANDART TİP BAKIR KABLOLAR İÇİN

KOD	KESİT	FİYAT
12.018	1 x 6 - 1 x 10 mm ²	55,00 TL.
12.019	1 x 16 - 1 x 25 mm ²	65,00 TL.
12.020	1 x 35 - 1 x 50 mm ²	75,00 TL.
12.021	1 x 70 - 1 x 95 mm ²	100,00 TL.
12.022	1 x 120 - 1 x 150 mm ²	150,00 TL.
12.023	1 x 185 - 1 x 240 mm ²	225,00 TL.
12.025	2 x 6 - 2 x 10 mm ²	75,00 TL.
12.026	2 x 16 - 2 x 25 mm ²	85,00 TL.
12.027	2 x 35 - 2 x 50 mm ²	110,00 TL.
12.028	2 x 70 - 2 x 95 mm ²	150,00 TL.
12.029	2 x 120 - 2 x 150 mm ²	280,00 TL.
12.030	2 x 185 mm ²	360,00 TL.
12.031	2 x 240 mm ²	400,00 TL.
12.032	3 x 4 - 3 x 6 mm ²	70,00 TL.
12.033	3 x 10 mm ²	90,00 TL.
12.034	3 x 16 mm ²	95,00 TL.
12.035	3 x 25 mm ²	100,00 TL.
12.036	3 x 35 mm ²	115,00 TL.
12.037	3 x 50 mm ²	140,00 TL.
12.038	3 x 70 mm ²	210,00 TL.
12.039	3 x 95 mm ²	235,00 TL.
12.040	3 x 120 mm ²	350,00 TL.
12.041	3 x 150 mm ²	400,00 TL.
12.042	3 x 185 mm ²	650,00 TL.
12.043	3 x 240 mm ²	700,00 TL.

ALÜMİNYUM İLETKENLİ ISI BÜZÜŞMELİ EK MUFLAR



ISI BÜZÜŞMELİ EK MUFLAR 1kV STANDART TİP ALÜMİNYUM KABLolar İÇİN

KOD	KESİT	FİYAT
12.057	4 x 16 mm ²	125,00 TL.
12.058	3 x 25 + 16 mm ²	185,00 TL.
12.059	3 x 35 + 16 mm ²	200,00 TL.
12.060	3 x 50 + 25 mm ²	250,00 TL.
12.061	3 x 70 + 35 mm ²	310,00 TL.
12.062	3 x 95 + 50 mm ²	425,00 TL.
12.063	3 x 120 + 70 mm ²	500,00 TL.
12.064	3 x 150 + 70 mm ²	550,00 TL.
12.065	3 x 185 + 95 mm ²	825,00 TL.
12.066	3 x 240 + 120 mm ²	900,00 TL.

ISI BÜZÜŞMELİ EK MUFLAR 1kV ÖZEL TİP ALÜMİNYUM KABLolar İÇİN

KOD	KESİT	BOY	FİYAT
12.069	1 x 16 - 1 x 25 mm ²		75,00 TL.
12.070	1 x 35 - 1 x 50 mm ²		85,00 TL.
12.071	1 x 70 - 1 x 95 mm ²		120,00 TL.
12.072	1 x 120 - 1 x 150 mm ²		150,00 TL.
12.073	1 x 185 - 1 x 240 mm ²		210,00 TL.
12.074	2 x 16 - 2 x 25 mm ²		90,00 TL.
12.075	2 x 35 - 2 x 50 mm ²		115,00 TL.
12.076	2 x 70 - 2 x 95 mm ²		170,00 TL.
12.077	2 x 120 mm ²		200,00 TL.
12.078	2 x 150 mm ²		210,00 TL.
12.079	2 x 185 mm ²		240,00 TL.
12.080	2 x 240 mm ²		270,00 TL.
12.081	3 x 16 mm ²		145,00 TL.
12.082	3 x 25 mm ²		150,00 TL.
12.083	3 x 35 mm ²		170,00 TL.
12.084	3 x 50 mm ²		180,00 TL.
12.085	3 x 70 mm ²		240,00 TL.
12.086	3 x 95 mm ²		265,00 TL.
12.087	3 x 120 mm ²		275,00 TL.
12.088	3 x 150 mm ²		320,00 TL.
12.089	3 x 185 mm ²		425,00 TL.
12.090	3 x 240 mm ²		475,00 TL.

KABLO BAĞLANTI ELEMANLARI



BAKIR BORU MUF

KOD	KESİT	KUTU AD.	FİYAT
21.001	2,5 mm	1000	6,25 TL.
21.002	4-6 mm	500	6,25 TL.
21.003	10 mm	500	6,50 TL.
21.004	16 mm	500	6,85 TL.
21.005	25 mm	250	12,50 TL.
21.006	35 mm	200	16,50 TL.
21.007	50 mm	150	20,00 TL.
21.008	70 mm	100	35,00 TL.
21.009	95 mm	75	40,00 TL.
21.010	120 mm	50	54,00 TL.
21.011	150 mm	40	90,00 TL.
21.012	185 mm	30	105,00 TL.
21.013	240 mm	20	165,00 TL.



U KLEMENS

KOD	KESİT	KUTU AD.	FİYAT
21.301	6 mm	150	16,50 TL.
21.302	10 mm	125	23,00 TL.
21.303	16 mm	100	32,50 TL.
21.304	25 mm	100	40,00 TL.
21.305	35 mm	75	46,00 TL.
21.306	50 mm	50	68,00 TL.
21.307	70 mm	40	82,00 TL.
21.308	95 mm	25	110,00 TL.
21.309	120 mm	20	150,00 TL.
21.310	150 mm	15	200,00 TL.



PIRİNÇ KANCA SERFİL

KOD	KESİT	KUTU AD.	FİYAT
21.201	16 mm	350	60,00 TL.
21.202	25 mm	300	65,00 TL.
21.203	35 mm	300	70,00 TL.
21.204	50 mm	250	75,00 TL.
21.205	70 mm	200	95,00 TL.
21.206	95 mm	175	110,00 TL.
21.207	120 mm	150	120,00 TL.
21.208	150 mm	100	150,00 TL.
21.209	185 mm	75	200,00 TL.
21.210	240 mm	60	250,00 TL.

BAKIR KABLO PABUÇLARI



BAKIR SKP (KABLO PABUCU) STANDART

KOD	KESİT	D. ÇAP	KUTU AD.	FİYAT
21.100	6 mm	M5	500	6,25 TL.
21.101	10 mm	M5	500	6,25 TL.
21.102	16 mm	M6	500	9,00 TL.
21.103	25 mm	M8	250	14,50 TL.
21.104	35 mm	M8	200	19,50 TL.
21.105	50 mm	M10	150	29,00 TL.
21.106	70 mm	M10	100	36,50 TL.
21.107	95 mm	M12	75	46,00 TL.
21.108	120 mm	M12	50	62,00 TL.
21.109	150 mm	M12	40	102,00 TL.
21.110	185 mm	M16	30	122,00 TL.
21.111	240 mm	M16	20	165,00 TL.

BAKIR SKP (KABLO PABUCU) EKO 1

KOD	KESİT	D. ÇAP	KUTU AD.	FİYAT
21.122	16 mm	M6	500	6,00 TL.
21.123	25 mm	M8	250	10,50 TL.
21.124	35 mm	M8	200	14,00 TL.
21.125	50 mm	M10	150	16,50 TL.
21.126	70 mm	M10	100	27,50 TL.
21.127	95 mm	M12	75	31,50 TL.
21.128	120 mm	M12	50	41,00 TL.
21.129	150 mm	M12	40	67,50 TL.
21.130	185 mm	M16	30	81,00 TL.
21.131	240 mm	M16	20	127,50 TL.

ALÜMİNYUM KABLO MUFLARI



ALÜMİNYUM BORU MUF

KOD	KESİT	KUTU AD.	FİYAT
21.017	16 mm	450	8,00 TL.
21.018	25 mm	300	10,00 TL.
21.019	35 mm	200	14,00 TL.
21.020	50 mm	150	18,50 TL.
21.021	70 mm	100	25,00 TL.
21.022	95 mm	75	34,00 TL.
21.023	120 mm	75	45,00 TL.
21.024	150 mm	50	55,00 TL.
21.025	185 mm	40	65,00 TL.
21.026	240 mm	30	80,00 TL.



ALÜMİNYUM SKP

KOD	KESİT	D. ÇAP	KUTU AD.	FİYAT
21.161	16 mm	M6	450	8,00 TL.
21.162	25 mm	M8	300	10,00 TL.
21.163	35 mm	M8	200	14,00 TL.
21.164	50 mm	M10	150	18,50 TL.
21.165	70 mm	M12	100	25,00 TL.
21.166	95 mm	M12	75	34,00 TL.
21.167	120 mm	M12	75	45,00 TL.
21.168	150 mm	M12	50	55,00 TL.
21.169	185 mm	M12	40	65,00 TL.
21.170	240 mm	M12	30	80,00 TL.

Bİ-METAL SKP

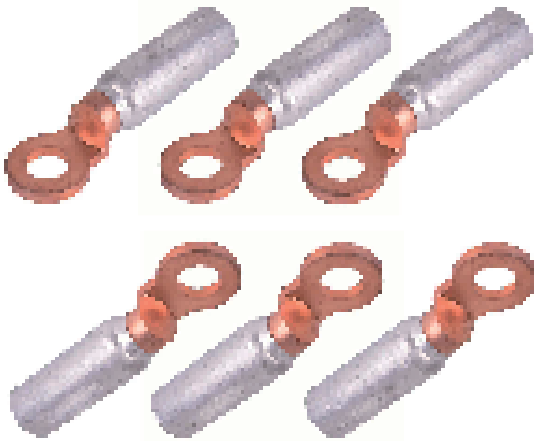

KOD	KESİT		KUTU AD.	FİYAT
21.422	16 mm	Bİ-METAL	450	62,50 TL.
21.423	25 mm	Bİ-METAL	300	62,50 TL.
21.424	35 mm	"	200	62,50 TL.
21.425	50 mm	"	150	87,50 TL.
21.426	70 mm	"	100	87,50 TL.
21.427	95 mm	"	75	87,50 TL.
21.428	120 mm	"	75	150,00 TL.
21.429	150 mm	"	50	150,00 TL.
21.430	185 mm	"	40	230,00 TL.
21.431	240 mm	"	30	230,00 TL.

OTOMASYON

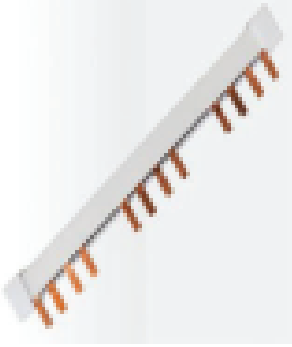

TRİFAZE BARA

KOD			KUTU AD.	FİYAT	
25.111	53 cm	1mm	63A 10 Modül	25	225,00 TL.
25.112	106 cm	1mm	63A 20 Modül	25	450,00 TL.
25.101	53 cm	1mm	80A 10 Modül	25	275,00 TL.
25.102	106 cm	1mm	80A 20 Modül	25	550,00 TL.
25.103	53 cm	1,5mm	100A 10 Modül	25	450,00 TL.
25.104	106 cm	1,5mm	100A 20 Modül	25	900,00 TL.



MONOFAZE BARA

KOD			KUTU AD.	FİYAT	
25.001	53 cm	1 mm	80A 30 Modül	50	100,00 TL.
25.002	106 cm	1 mm	80A 60 Modül	50	200,00 TL.
25.003	53 cm	1,5 mm	100A 30 Modül	50	175,00 TL.
25.004	106 cm	1,5 mm	100A 60 Modül	50	350,00 TL.



TOPRAKLAMA BARASI

KOD			KUTU AD.	FİYAT
25.201	1,5 mm	31 Vida	40	300,00 TL.
25.202	1,5 mm	61 Vida	40	375,00 TL.
25.203	2 mm	31 Vida	40	350,00 TL.
25.204	2 mm	61 Vida	40	450,00 TL.



TIRNAKLI KLEMENS

KOD			KUTU AD.	FİYAT
25.300	10 mm	No: 1	150	34,00 TL.
25.301	16 mm	No: 2	150	48,00 TL.
25.302	25 mm	No: 3	100	78,00 TL.
25.303	35 mm	No: 4	100	94,00 TL.
25.304	50 mm	No: 5	50	144,00 TL.
25.305	70 mm	No: 6	50	222,00 TL.
25.306	95 mm	No: 7	30	250,00 TL.
25.307	120 mm	No: 8	30	300,00 TL.



W OTOMAT RAYI (DÜZ)

KOD			KUTU AD.	FİYAT
25.401	1 Metre		50	37,50 TL.
25.402	2 Metre			75,00 TL.

ISO 9001 : 2015



Registration Certificate

This is to certify that
The Quality Management Systems
of

**KETENCİ SANAYİ VE TİCARET KOLLEKTİF
ŞİRKETİ ERDAL KILIÇ VE ORTAĞI**

Carried out at following site:

Fabrika: Orta Mahallesi Topkapı Maltepe Caddesi No: 29-30/6 Bayrampaşa
İSTANBUL/Türkiye

&

Merkez: Bankalar Caddesi, Emekyemez Mahallesi, Tutuk Sokak, Sarıtepe
Han No:10 80020 Karaköy İSTANBUL/Türkiye

for their

QUALITY MANAGEMENT SYSTEM ISO 9001:2015

Scope of Activities covered by this Registration:

Design, Manufacture and Sales of Switch, Isolator, Cable Caps, Termo-Plastic and Refillable
Filling Material, Cable Joint, Refillable Plastic Cable Joints, Socket and Socket Box.
(Şalter, İzolatör, Kablo Başlıklar, Termo Plastik ve Yeniden Dolunabilirlik Dolgu
Malzemesi, Ek Maf, Yeniden Dolunabilirlik Plastik Ek Maf, Priz ve Priz Kutusu
Tasarımı, Üretimi ve Satışı.)

CERTIFICATE NO. : IAS/QMS/02017

ISSUED ON : 24/09/2019

1st SURVEILLANCE DUE ON: 24/09/2020

VALIDITY DATE : 23/09/2022

2nd SURVEILLANCE DUE ON: 24/09/2021

THE VALIDITY OF CERTIFICATE IS SUBJECT TO REGULAR SURVEILLANCE AUDIT ON OR
BEFORE ABOVE MENTIONED DATES AND IT'S ONLY VALID AFTER SUCCESSFUL
SURVEILLANCE WITH CONTINUATION LETTER ISSUED BY CCPL.

TO VERIFY THIS CERTIFICATE STATUS PLEASE VISIT AT <https://ccpl.com/certification.com>

AUTHORIZED BY
CHAIRMAN / DIRECTOR

CARE CERTIFICATION PRIVATE LIMITED

THE QUALITY SYSTEM CERTIFICATION

WWW.CARECERTIFICATION.COM

Address: K24 House, 160 City Road,

LONDON, EC1Y 2ON, United Kingdom

For Contact please visit <https://ccpl.com/certification.com>



CCPL is accredited by International Accreditation Service (IAS) United States of America

ISO 14001 : 2015



Registration Certificate

This is to certify that
The Management Systems of

**KETENCİ SANAYİ VE TİCARET KOLLEKTİF
ŞİRKETİ ERDAL KILIÇ VE ORTAĞI**

Carried out at following site:

Fabrika: Orta Mahallesi Topkapı Maltepe Caddesi No: 28-30/6 Bayrampasa
/İSTANBUL/Türkiye

&

Merkez: Bankalar Caddesi, Emekyemez Mahallesi, Tutuk Sokak, Sarıoğlu
Han No:10 80020 Karaköy İSTANBUL/Türkiye

for their

ENVIRONMENTAL MANAGEMENT SYSTEM ISO 14001:2015

Scope of Activities covered by this Registration:

Design, Manufacture and Sales of Switch, Isolator, Cable Caps, Termo-Plastic and Refillable
Filling Material, Cable Joint, Refillable Plastic Cable Joints, Socket and Socket Box.
(Şalter, İzolatör, Kablo Başlıkları, Termo-Plastik ve Yeniden Doldürülebilir Dolgu
Malzemesi, Ek Mal, Yeniden Doldürülebilir Plastik Ek Malı, Frik ve Frik Kutusu
Tasarımı, Üretimi ve Satışı.)

CERTIFICATE NO. : IAS/EMS/01 141

ISSUED ON : 24/08/2019

1ST SURVEILLANCE DUE ON: 24/08/2020

VALIDITY DATE : 23/08/2022

2ND SURVEILLANCE DUE ON: 23/08/2021

THE VALIDITY OF CERTIFICATE IS SUBJECT TO REGULAR SURVEILLANCE AUDIT ON OR
BEFORE ABOVE MENTIONED DATES AND IT'S ONLY VALID AFTER SUCCESSFUL
SURVEILLANCE WITH CONTINUATION LETTER ISSUED BY CCPL.

TO VERIFY THIS CERTIFICATE STATUS PLEASE VISIT AT <http://ccplcertification.com>

Authorised by
CHAIRMAN / DIRECTOR
CARE CERTIFICATION PRIVATE LIMITED

Third Party Certification

www.carecertification.com

Address: -ConHouse, 150 City Road,

LONDON, EC1Y 2SH, UNITED KINGDOM

ISO CERTIFICATION NUMBER: IAS/EMS/01 141 AND CONTACT INFORMATION



CCPL is accredited by International Accreditation Service (IAS) United States of America



Merkez : Bankalar Cad. Emekyemez Mah. Okçumusa Cad. Tutsak Sk. Sarioğlu İş Hanı No:10 D:3 34421 Karaköy/İST.
 Tel: 0 212 237 70 02 Gsm: 0533 326 45 25
 info@ketenci.com.tr * www.ketenci.com.tr