

SOLMAZSAN®

FİYAT LİSTESİ

0 c a k 2 0 2 3

www.solmazsan.com.tr

Değerli çözüm ortağımız;

2009 yılında kurulan Solmazsan Elektrik Malzemeleri ve Klemens İmalat San. Tic. Ltd. Şti. enerji sektöründe sahip olduğu bilgi, tecrübe ve deneyimleriyle siz değerli çözüm ortaklarına uygun fiyat ve kaliteli ürün sunmayı ilke edinmiş olup, bu doğrultuda çalışmalarına devam etmektedir.

Güvenilirlik ilkesine bağlı birçok yenilikler ve çalışmalar ortaya koymuş olan firmamız bundan sonraki süreçte de ilkelerinden taviz vermeden alanındaki çalışmalarını genişleterek devam etmeyi hedeflemektedir.

Bizlere bu yolda yardımcı olan siz değerli çözüm ortaklarımız ve bayiliğini yaptığımız firmalara teşekkür ederiz.

Saygılarımızla,

SOLMAZSAN®



İNDEKS

- 4** KABLO PAPUCU ve EK MUFLAR
- 8** BUAT İÇİ BAĞLANTI KLEMENSLERİ
- 11** PANO İÇİ DAĞITIM ve BAĞLANTI KLEMENSLERİ
- 16** KABLO YÜKSÜKLERİ ve UÇLARI
- 20** KABLO BAĞLARI ve ETİKETLERİ
- 23** BUTON ve AKSESUARLARI
- 26** SİVİÇLER, VİNÇ KUMANDA BUTONLARI ve PEDALLAR
- 29** MESNET İZOLATÖRLERİ
- 32** PANO AKSESUARLARI ve BANTLAR
- 37** HAVAI HAT BAĞLANTI KLEMENSLERİ ve O.G. SİGORTALAR
- 40** KAUÇUK FİŞ - PRİZ, AKSESUARLARI ve EL ALETLERİ
- 44** OTOMATİK BASINÇ KONTROL SİSTEMLERİ ve FLATÖRLER
- 47** REÇİNELİ ve ISI BÜZÜŞMELİ KABLO EK MUFLARI

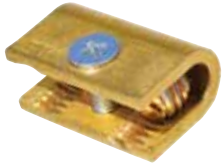

KABLO PAPUCU & EK MUFLAR

SOLMAZSAN®

EKO SKP (Kısa Tip) (BAKIR İLETKEN)

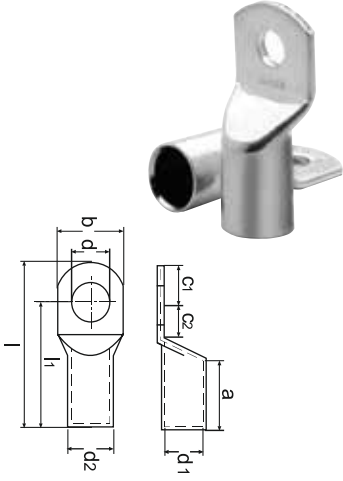

ÜRÜN KODU	KESİT	METRİK	d	d1	d2	l	l1	a	b	c1	c2	K.AD.	₺ / ADET
SK 6027	16 mm ²	M6	6,5	5,6	7,8	29,5	24,0	12,0	11,2	5,5	6,5	500	4,50
SK 6028	25 mm ²	M8	8,5	7,1	9,5	39,0	32,2	16,0	13,7	6,8	9,2	300	9,00
SK 6029	35 mm ²	M8	8,5	8,2	10,8	44,0	35,7	19,0	15,3	8,3	9,7	200	12,00
SK 6030	50 mm ²	M10	10,5	10,1	13,0	51,5	41,5	21,0	18,9	10,0	12,0	125	16,50
SK 6031	70 mm ²	M10	10,5	11,5	14,7	54,6	44,6	23,0	21,1	10,0	12,0	100	24,50
SK 6032	95 mm ²	M12	13,0	13,5	16,7	58,8	49,8	26,0	24,7	10,0	12,0	75	30,50
SK 6033	120 mm ²	M12	13,0	15,6	19,0	69,0	56,0	29,0	27,7	13,0	14,5	50	44,50
SK 6034	150 mm ²	M12	13,0	16,5	21,0	76,5	60,0	30,0	30,4	16,5	16,5	40	66,00
SK 6035	185 mm ²	M16	15,0	18,4	23,0	82,5	65,5	33,0	34,2	17,0	18,0	25	84,00
SK 6036	240 mm ²	M16	15,0	21,0	26,0	89,	72,0	38,0	38,7	17,0	18,0	20	122,00
SK 6037	300 mm ²	M16	16,0	21,0	27,0	91,0	72,0	39,0	40,0	17,0	18,0	20	170,00

STANDART SKP (Uzun ve Kalın Tip) (BAKIR İLETKEN)



ÜRÜN KODU	KESİT	METRİK	d	d1	d2	l	l1	a	b	c1	c2	K.AD.	₺ / ADET
SK 6026/S	10 mm ²	M5	5,5	4,7	6,6	27,5	22,0	10,0	10,3	5,5	7,0	800	4,60
SK 6026/M8	10 mm ²	M8	8,5	4,7	6,6	30,5	23,7	10,0	13,5	6,8	8,7	800	4,60
SK 6027/S	16 mm ²	M6	6,5	5,6	7,8	29,5	24,0	12,0	11,2	5,5	6,5	500	7,00
SK 6027/M8	16 mm ²	M8	8,5	5,6	7,8	33,0	26,2	12,0	13,5	6,8	8,7	500	7,00
SK 6028/S	25 mm ²	M8	8,5	7,1	9,5	39,0	32,2	16,0	13,7	6,8	9,2	275	12,00
SK 6029/S	35 mm ²	M8	8,5	8,2	10,8	44,0	35,7	19,0	15,3	8,3	9,7	175	16,00
SK 6030/S	50 mm ²	M10	10,5	10,1	13,0	51,5	41,5	21,0	18,9	10,0	12,0	100	23,00
SK 6031/S	70 mm ²	M10	10,5	11,5	14,7	54,6	44,6	23,0	21,1	10,0	12,0	90	34,00
SK 6032/S	95 mm ²	M12	13,0	13,5	16,7	58,8	49,8	26,0	24,7	10,0	12,0	60	43,50
SK 6033/S	120 mm ²	M12	13,0	15,6	19,0	69,0	56,0	29,0	27,7	13,0	14,5	50	58,00
SK 6034/S	150 mm ²	M12	13,0	16,5	21,0	76,5	60,0	30,0	30,4	16,5	16,5	30	90,00
SK 6035/S	185 mm ²	M16	15,0	18,4	23,0	82,5	65,5	33,0	34,2	17,0	18,0	25	115,00
SK 6036/S	240 mm ²	M16	15,0	21,0	26,0	89,	72,0	38,0	38,7	17,0	18,0	20	150,00
SK 6037/S	300 mm ²	M16	16,0	21,0	27,0	91,0	72,0	39,0	39,5	17,0	18,0	20	180,00

ALÜMİNYUM SKP (ALÜMİNYUM İLETKEN)

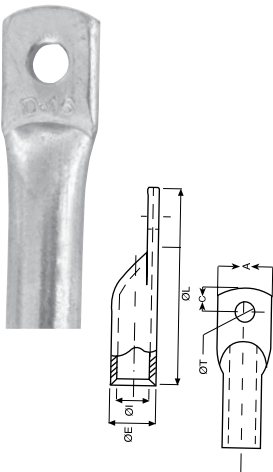

ÜRÜN KODU	KESİT	METRİK	L	K.AD.	₺ / ADET
SKP-AL16	16 mm ²	M6	56	300	7,50
SKP-AL25	25 mm ²	M8	64	150	10,95
SKP-AL35	35 mm ²	M10	73	100	13,50
SKP-AL50	50 mm ²	M10	81	75	18,00
SKP-AL70	70 mm ²	M10	94	50	26,00
SKP-AL95	95 mm ²	M12	102	50	34,00
SKP-AL120	120 mm ²	M12	112	20	38,50
SKP-AL150	150 mm ²	M14	114	20	54,00
SKP-AL185	185 mm ²	M14	125	20	72,00
SKP-AL240	240 mm ²	M14	141	12	90,00

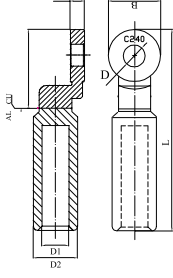

AL-CU SKP (BİMETAL)

ÜRÜN KODU	KESİT	METRİK	L	B	K.AD.	\$/ADET
TBF-16	16 mm ²	M8	84	16	100	3,30
TBF-25	25 mm ²	M8	84	25	100	3,30
TBF-35	35 mm ²	M8	84	35	100	3,50
TBF-50	50 mm ²	M10	84	50	50	4,50
TBF-70	70 mm ²	M10	84	70	50	4,50
TBF-95	95 mm ²	M12	84	95	50	4,60
TBF-120	120 mm ²	M12	107	120	30	7,20
TBF-150	150 mm ²	M12	107	150	30	7,20
TBF-185	185 mm ²	M16	117	185	20	11,80
TBF-240	240 mm ²	M16	117	240	20	11,80

45° AÇILI SKP (BAKIR İLETKEN)



ÜRÜN KODU	KESİT	METRİK	AÇIKLAMA	K.AD.	₺ / ADET
SK-6306	16 mm ²	M6	45° Açılı Kablo Pabucu	200	Fiyat Sorunuz
SK-6307	25 mm ²	M8		100	
SK-6308	35 mm ²	M8		100	
SK-6309	50 mm ²	M10		100	
SK-6310	70 mm ²	M10		50	
SK-6311	95 mm ²	M12		50	
SK-6312	120 mm ²	M12		30	
SK-6313	150 mm ²	M12		20	
SK-6314	185 mm ²	M12		20	
SK-6315	240 mm ²	M12		10	

90° AÇILI SKP (BAKIR İLETKEN)



ÜRÜN KODU	KESİT	METRİK	AÇIKLAMA	K.AD.	₺ / ADET
SK-6316	16 mm ²	M6	90° Açılı Kablo Pabucu	200	Fiyat Sorunuz
SK-6317	25 mm ²	M8		100	
SK-6318	35 mm ²	M8		100	
SK-6319	50 mm ²	M10		100	
SK-6320	70 mm ²	M10		50	
SK-6321	95 mm ²	M12		50	
SK-6322	120 mm ²	M12		30	
SK-6323	150 mm ²	M12		20	
SK-6324	185 mm ²	M12		20	
SK-6325	240 mm ²	M12		10	

ÇİFT DELİKLİ SKP (BAKIR İLETKEN)



ÜRÜN KODU	KESİT	METRİK	AÇIKLAMA	K.AD.	₺ / ADET
SKÇ-6326	16 mm ²	M5/6	Çift Delikli Kablo Pabucu	200	Fiyat Sorunuz
SKÇ-6327	25 mm ²	M8/10		100	
SKÇ-6328	35 mm ²	M8/10		100	
SKÇ-6329	50 mm ²	M8/10		100	
SKÇ-6330	70 mm ²	M10/12		50	
SKÇ-6331	95 mm ²	M10/12/14		50	
SKÇ-6332	120 mm ²	M10/12/14		30	
SKÇ-6333	150 mm ²	M10/12/16		20	
SKÇ-6334	185 mm ²	M10/12/16		20	
SKÇ-6335	240 mm ²	M10/12/16		10	

SEM EK MUFLARI (BAKIR İLETKEN)

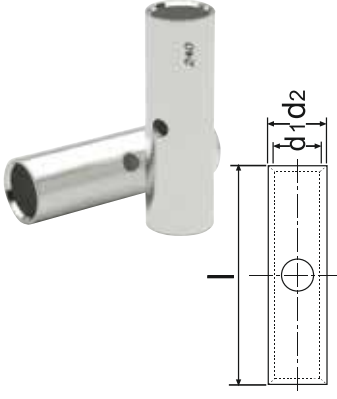

ÜRÜN KODU	KESİT	d1	d2	l	K.AD.	₺ / ADET
SK 7062	16 mm ²	5,6	7,8	32,0	500	5,10
SK 7063	25 mm ²	7,1	9,5	40,5	350	9,90
SK 7064	35 mm ²	8,2	10,8	45,5	200	13,30
SK 7065	50 mm ²	10,1	13,0	53,5	150	17,70
SK 7066	70 mm ²	11,5	14,7	57,5	100	26,60
SK 7067	95 mm ²	13,5	16,7	61,5	80	33,00
SK 7068	120 mm ²	15,6	19,0	74,0	50	47,50
SK 7069	150 mm ²	16,5	21,0	79,0	40	72,00
SK 7070	185 mm ²	18,4	23,0	85,0	30	91,00
SK 7071	240 mm ²	21,0	26,0	94,0	25	133,00

SEM EK MUFLARI (ALÜMİNYUM İLETKEN)

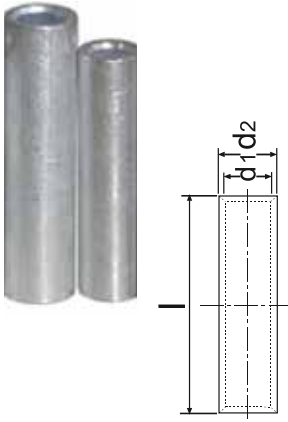

ÜRÜN KODU	KESİT	d1	d2	l	K.AD.	₺ / ADET
SK 7062-A	16 mm ²	5,6	7,8	32,0	200	7,70
SK 7063-A	25 mm ²	7,1	9,5	40,5	125	10,50
SK 7064-A	35 mm ²	8,2	10,8	45,5	100	12,45
SK 7065-A	50 mm ²	10,1	13,0	53,5	75	18,00
SK 7066-A	70 mm ²	11,5	14,7	57,5	50	22,50
SK 7067-A	95 mm ²	13,5	16,7	61,5	40	31,00
SK 7068-A	120 mm ²	15,6	19,0	74,0	25	49,00
SK 7069-A	150 mm ²	16,5	21,0	79,0	20	52,00
SK 7070-A	185 mm ²	18,4	23,0	85,0	15	63,00
SK 7071-A	240 mm ²	21,0	26,0	94,0	15	81,00

U KLEMENSLER



ÜRÜN KODU	AÇIKLAMA	KUTU ADEDİ	₺ / ADET
SK 7050	6 mm ² U klemens	150	11,00
SK 7051	10 mm ² U klemensv	125	14,80
SK 7052	16 mm ² U klemens	100	23,00
SK 7053	25 mm ² U klemens	100	27,50
SK 7054	35 mm ² U klemens	75	33,00
SK 7055	50 mm ² U klemens	50	60,50
SK 7056	70 mm ² U klemens	40	71,50
SK 7057	95 mm ² U klemens	25	85,60
SK 7058	120 mm ² U klemens	20	114,00
SK 7059	150 mm ² U klemens	15	153,00

PORSELEN KLEMENSLER



ÜRÜN KODU	AÇIKLAMA	KUTU ADEDİ	₺ / ADET
SK 601	NO : 1, 2'li lüster	144	12,00
SK 602	NO : 1, 3'lü lüster	80	16,50
SK 603	NO : 2, 2'li lüster	84	16,50
SK 604	NO : 2, 3'lü lüster	48	22,50
SK 605	NO : 3, 2'li lüster	50	22,50
SK 606	NO : 3, 3'lü lüster	30	31,50
SK 607	NO : 1, 1'li lüster	120	11,25
SK 609	NO : 3, 1'li lüster	100	21,60
SK 610	NO : 4, 2'li lüster	40	31,50



BUAT İÇİ BAĞLANTI KLEMENSLERİ

SOLMAZSAN®

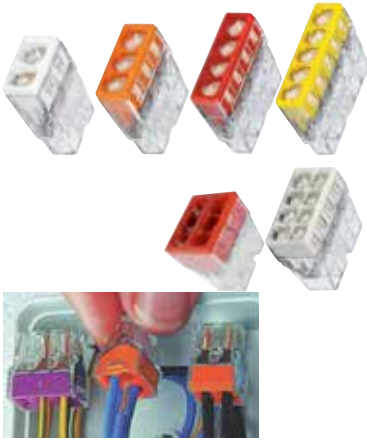

GEÇMELİ BUAT KLEMENSLER

ÜRÜN KODU	KABLO KESİTİ	BAĞLANTI	KUTU ADEDİ	₺ / ADET
SK 8310	2,5 mm ²	2	600	2,78
SK 8311	2,5 mm ²	3	600	2,99
SK 8312	2,5 mm ²	4	300	3,55
SK 8313	2,5 mm ²	5	300	3,88
SK 8315	2,5 mm ²	6	300	4,77
SK 8314	2,5 mm ²	8	200	5,99



AÇ - KAPA BUAT KLEMENSLER

ÜRÜN KODU	KABLO KESİTİ	BAĞLANTI	KUTU ADEDİ	₺ / ADET
SK 8840	2,5 mm ²	2	300	5,33
SK 8842	2,5 mm ²	3	200	6,99
SK 8843	2,5 mm ²	4	150	8,55
SK 8844	2,5 mm ²	5	150	9,99

PLASTİK SIRA KLEMENSLER (EKO) M8 Prinç

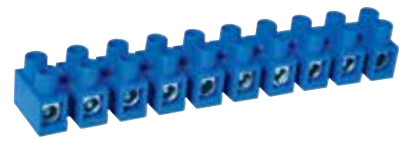

ÜRÜN KODU	BOY	KABLO KESİTİ	BAĞLANTI	AMPER	KUTU ADEDİ	₺ / ADET
SK 101 E	No 1	2,5 - 4 mm ²	12	32	50	28,00
SK 102 E	No 2	4 - 6 mm ²	12	41	50	33,50
SK 103 E	No 3	6 - 10 mm ²	10	57	50	42,00
SK 104 E	No 4	10 - 16 mm ²	6	76	50	49,50
SK 105 E	No 5	16 - 25 mm ²	6	101	50	59,50

ISIYA DAYANIKLI PLASTİK SIRA KLEMENSLER (EKO) M8 Prinç



ÜRÜN KODU	BOY	KABLO KESİTİ	BAĞLANTI	AMPER	KUTU ADEDİ	₺ / ADET
SK 201 E	No 1	2,5 - 4 mm ²	12	32	50	30,00
SK 202 E	No 2	4 - 6 mm ²	12	41	50	36,00
SK 203 E	No 3	6 - 10 mm ²	10	57	50	45,00
SK 204 E	No 4	10 - 16 mm ²	6	76	50	52,50
SK 205 E	No 5	16 - 25 mm ²	6	101	50	63,00

PLASTİK SIRA KLEMENSLER M8 Prinç

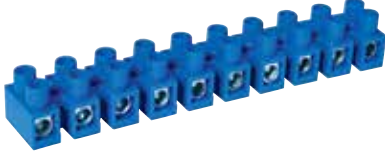

ÜRÜN KODU	BOY	KABLO KESİTİ	BAĞLANTI	AMPER	KUTU ADEDİ	₺ / ADET
SK 101	No 1	2,5 - 4 mm ²	12	32	50	30,00
SK 102	No 2	4 - 6 mm ²	12	41	50	41,00
SK 103	No 3	6 - 10 mm ²	10	57	50	49,50
SK 104	No 4	10 - 16 mm ²	6	76	50	64,50
SK 105	No 5	16 - 25 mm ²	6	101	50	73,50

ISIYA DAYANIKLI PLASTİK SIRA KLEMENSLER M8 Prinç



ÜRÜN KODU	BOY	KABLO KESİTİ	BAĞLANTI	AMPER	KUTU ADEDİ	₺ / ADET
SK 201	No 1	2,5 - 4 mm ²	12	32	50	31,50
SK 202	No 2	4 - 6 mm ²	12	41	50	43,50
SK 203	No 3	6 - 10 mm ²	10	57	50	52,50
SK 204	No 4	10 - 16 mm ²	6	76	50	67,50
SK 205	No 5	16 - 25 mm ²	6	101	50	76,50

SOKET KLEMENSLER (MS 58 PİRİNÇ İLETKEN - 24 A)



ÜRÜN KODU	AÇIKLAMA	KUTU ADEDİ	₺ / ADET
5068	2'li Geçmeli Soket Klemens - Beyaz	50	Fiyat Sorunuz
5042	2'li Geçmeli Soket Klemens - Siyah	50	
5065	3'lü Geçmeli Soket Klemens - Beyaz	50	
5411	3'lü Geçmeli Soket Klemens - Siyah	50	
5060	12'li Geçmeli Soket Klemens - Beyaz	25	
5405	12'li Geçmeli Soket Klemens - Siyah	25	





PANO İÇİ DAĞITIM & BAĞLANTI KLEMENSLERİ

SOLMAZSAN®

TRİFAZE MÜŞTEREK W OTOMAT BARASI

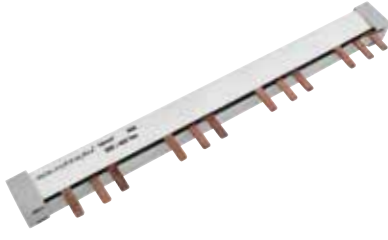

ÜRÜN KODU	ÖLÇÜ	AKIM (A)	MODÜL	KOLİ ADEDİ	₺ / ADET
SK 3043	53 cm	63 (1 mm)	10	25	220,00
SK 3044	53 cm	80 (1 mm)	10	25	280,00
SK 3054	53 cm	125 (1,5 mm)	10	25	440,00
SK 3046	106 cm	63 (1 mm)	20	25	440,00
SK 3045	106 cm	80 (1 mm)	20	25	560,00
SK 3055	106 cm	125 (1,5 mm)	20	25	880,00

MONOFAZE MÜŞTEREK W OTOMAT BARASI

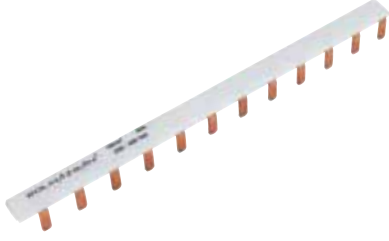

ÜRÜN KODU	ÖLÇÜ	AKIM (A)	MODÜL	KOLİ ADEDİ	₺ / ADET
SK 3003	53 cm	63 (0,8 mm)	30	50	69,00
SK 3004	106 cm	63 (0,8 mm)	60	50	138,00
SK 3005	53 cm	80 (1 mm)	30	50	99,00
SK 3006	106 cm	80 (1 mm)	30	50	198,00
SK 3015	106 cm	125 (1,5 mm)	60	50	310,00

NÖTR TOPRAKLAMA BARASI



ÜRÜN KODU	ÖLÇÜ	AKIM (A)	MODÜL	KOLİ ADEDİ	₺ / ADET
SK 3075	15 x 1,5	100	31	40	244,50
SK 3076	15 x 1,5	100	61	40	310,00
SK 3085	15 x 2,0	100	31	40	303,00
SK 3086	15 x 2,0	100	61	40	375,00

PANO TOPRAKLAMA KLEMENSİ - AYAKSIZ (6 x 8 mm) 63 A

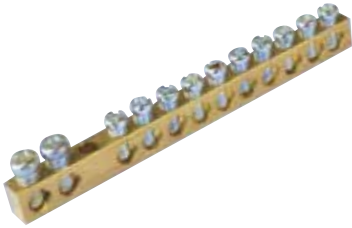

ÜRÜN KODU	AÇIKLAMA	L	B	H	KOLİ ADEDİ	₺ / ADET
SK 1004	2/2 4 delikli	33	6,5	9	100	11,90
SK 1005	2/3 5 delikli	38	6,5	9	100	12,60
SK 1006	2/4 6 delikli	45	6,5	9	100	16,80
SK 1007	2/5 7 delikli	50	6,5	9	100	17,73
SK 1009	2/7 9 delikli	62	6,5	9	100	19,80
SK 1010	2/8 10 delikli	68	6,5	9	100	22,50
SK 1012	2/10 12 delikli	80	6,5	9	100	28,80
SK 1022	2/20 22 delikli	133	6,5	9	50	
SK 909	2/40 42 delikli	274	6,5	9	50	
SK 910	2/60 62 delikli	395	6,5	9	50	
SK 911	2/80 82 delikli	520	6,5	9	50	

Fiyat Sorunuz

PANO TOPRAKLAMA KLEMENSİ - AYAKSIZ (6,5 x 9 mm) 80 A

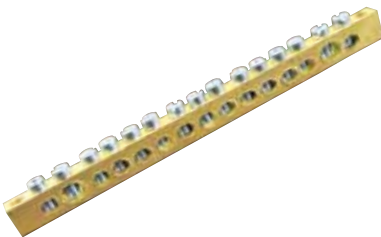

ÜRÜN KODU	AÇIKLAMA	L	L2	B	H	KOLİ ADEDİ	₺ / ADET
SK 1206	6 delikli	65	50	6,5	9	50	27,50
SK 1207	7 delikli	71	56	6,5	9	50	30,50
SK 1210	10 delikli	88	73	6,5	9	50	36,70
SK 1212	12 delikli	100	85	6,5	9	50	39,50
SK 1215	15 delikli	118	103	6,5	9	50	48,25
SK 1220	20 delikli	146	133	6,5	9	50	64,50
SK 1225	25 delikli	177	162	6,5	9	50	81,50
SK 1230	30 delikli	206	191	6,5	9	50	116,50

PANO TOPRAKLAMA KLEMENSİ - AYAKSIZ (7x 12 mm) 125 A

ÜRÜN KODU	AÇIKLAMA	L	L2	B	H	KOLİ ADEDİ	₺ / ADET
SK 1306	6 delikli	65	50	7	12	50	37,80
SK 1307	7 delikli	71	56	7	12	50	39,90
SK 1310	10 delikli	88	73	7	12	50	47,50
SK 1312	12 delikli	100	85	7	12	50	56,70
SK 1315	15 delikli	118	103	7	12	50	72,00
SK 1320	20 delikli	146	133	7	12	50	90,00
SK 1325	25 delikli	177	162	7	12	50	120,50
SK 1330	30 delikli	206	191	7	12	50	162,00



TEK KUTUPLU DAĞITICI ÜNİTE (6,5 x 9 mm) 80 A

ÜRÜN KODU	AÇIKLAMA	L	L2	H	KOLİ ADEDİ	₺ / ADET
SK 1106/A	6 delikli, ayaklı	100	87	22	50	28,00
SK 1107/A	7 delikli, ayaklı	106	93	22	50	30,50
SK 1110/A	10 delikli, ayaklı	124	100	22	50	37,80
SK 1112/A	12 delikli, ayaklı	135	124	22	50	40,50
SK 1115/A	15 delikli, ayaklı	155	142	22	50	48,50
SK 1120/A	20 delikli, ayaklı	186	173	22	50	64,50
SK 1125/A	25 delikli, ayaklı	218	205	22	50	82,00
SK 1130/A	30 delikli, ayaklı	245	232	22	50	117,00

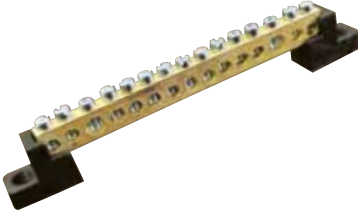

TEK KUTUPLU DAĞITICI ÜNİTE (7 x 12 mm) 125 A

ÜRÜN KODU	AÇIKLAMA	L	L2	H	KOLİ ADEDİ	₺ / ADET
SK 1306/A	6 delikli, ayaklı	104	70	22	50	38,00
SK 1307/A	7 delikli, ayaklı	104	91	22	50	40,00
SK 1310/A	10 delikli, ayaklı	128	115	22	50	47,80
SK 1312/A	12 delikli, ayaklı	145	130	22	50	57,00
SK 1315/A	15 delikli, ayaklı	162	150	22	50	72,30
SK 1320/A	20 delikli, ayaklı	200	187	22	50	90,00
SK 1325/A	25 delikli, ayaklı	238	225	22	50	121,00
SK 1330/A	30 delikli, ayaklı	275	262	22	50	162,50

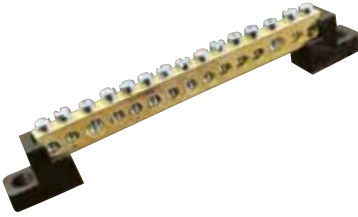

EŞ POTANSİYEL BARA 5x20 mm 250A (PLASTİK AYAK)

ÜRÜN KODU	AÇIKLAMA	L	B	H	KOLİ ADEDİ	₺ / ADET
SK 3708	1 giriş 7 çıkış	220	-	39	1	302,50
SK 3711	1 giriş 10 çıkış	270	-	39	1	378,00
SK 3715	1 giriş 14 çıkış	345	-	39	1	475,00

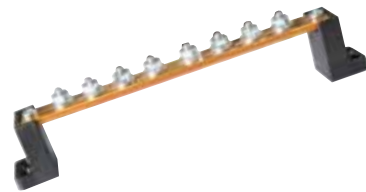

EŞ POTANSİYEL BARA 5x20 mm 250A (İZOLATÖR AYAK)

ÜRÜN KODU	AÇIKLAMA	L	B	H	KOLİ ADEDİ	₺ / ADET
SK 3608	1 giriş 7 çıkış	200	-	45	1	350,00
SK 3611	1 giriş 10 çıkış	260	-	45	1	432,00
SK 3615	1 giriş 14 çıkış	335	-	45	1	522,00

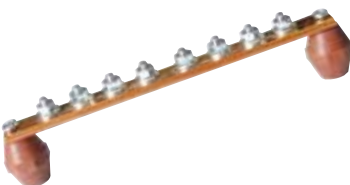

2 KUTUPLU DAĞITICI ÜNİTE (6,5 x 9 mm) 80 A



ÜRÜN KODU	AÇIKLAMA	L	B	H	KUTU ADEDİ	₺ / ADET
SK 1407/80	2/5 7 delikli	65	45	47	1	101,00
SK 1410/80	2/8 10 delikli	88	45	47	1	128,50
SK 1412/80	2/10 12 delikli	102	45	47	1	146,00
SK 1415/80	2/13 15 delikli	126	45	47	1	158,50
SK 1420/80	2/18 20 delikli	162	45	47	1	194,50
SK 1422/80	2/20 22 delikli	175	45	47	1	212,00

2 KUTUPLU DAĞITICI ÜNİTE (7 x 12 mm) 125 A

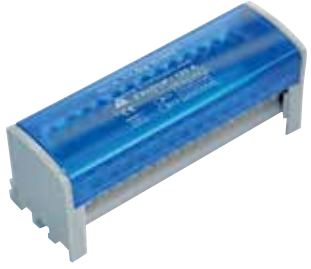

ÜRÜN KODU	AÇIKLAMA	L	B	H	KUTU ADEDİ	₺ / ADET
SK 1407	2/5 7 delikli	65	45	47	1	115,00
SK 1410	2/8 10 delikli	88	45	47	1	150,50
SK 1412	2/10 12 delikli	102	45	47	1	173,00
SK 1415	2/13 15 delikli	126	45	47	1	210,00
SK 1420	2/18 20 delikli	162	45	47	1	268,00
SK 1422	2/20 22 delikli	175	45	47	1	293,50

4 KUTUPLU DAĞITICI ÜNİTE (6,5 x 9 mm) 80 A



ÜRÜN KODU	AÇIKLAMA	L	B	H	KUTU ADEDİ	₺ / ADET
SK 1607/80	2/5 7 delikli	65	45	47	1	212,50
SK 1610/80	2/8 10 delikli	88	45	47	1	268,00
SK 1612/80	2/10 12 delikli	102	45	47	1	306,00
SK 1615/80	2/13 15 delikli	126	45	47	1	353,00
SK 1620/80	2/18 20 delikli	162	45	47	1	442,00
SK 1622/80	2/20 22 delikli	175	45	47	1	483,00

4 KUTUPLU DAĞITICI ÜNİTE (7 x 12 mm) 125 A



ÜRÜN KODU	AÇIKLAMA	L	B	H	KUTU ADEDİ	₺ / ADET
SK 1607	2/5 7 delikli	65	45	47	1	223,00
SK 1610	2/8 10 delikli	88	45	47	1	284,00
SK 1612	2/10 12 delikli	102	45	47	1	330,00
SK 1615	2/13 15 delikli	126	45	47	1	403,00
SK 1620	2/18 20 delikli	162	45	47	1	517,00
SK 1622	2/20 22 delikli	175	45	47	1	568,00

4 KUTUPLU DAĞITICI ÜNİTE (7 x 12 mm) 125 A - YÜKSEK MODEL

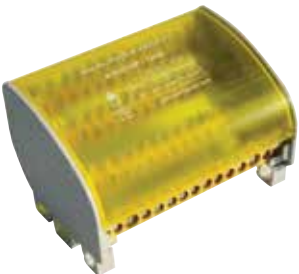

ÜRÜN KODU	AÇIKLAMA	L	B	H	KUTU ADEDİ	₺ / ADET
SK 1507	2/5 7 delikli	65	90	50	1	261,00
SK 1510	2/8 10 delikli	87	90	50	1	280,00
SK 1512	2/10 12 delikli	102	90	50	1	315,00
SK 1515	2/13 15 delikli	126	90	50	1	388,00
SK 1520	2/18 20 delikli	162	90	50	1	507,00
SK 1522	2/20 22 delikli	175	90	50	1	540,00
SK 1525	2/23 25 delikli	197	90	50	1	625,00

35 x 7,5 mm SAC MONTAJ RAYLARI

ÜRÜN KODU	ÖLÇÜ	AÇIKLAMA	KOLİ ADEDİ	₺ / ADET
SK 4001	30 cm	Düz W otomat rayı	50	8,50
SK 4002	100 cm	Düz W otomat rayı	50	28,00
SK 4003	200 cm	Düz W otomat rayı	25	56,00
SK 4011	30 cm	Delikli W otomat rayı	50	8,50
SK 4012	100 cm	Delikli W otomat rayı	50	28,00
SK 4013	200 cm	Delikli W otomat rayı	25	56,00

*İstenilen ölçüde ray kesilebilir.



Onka®

DAĞITICI ÜNİTELER

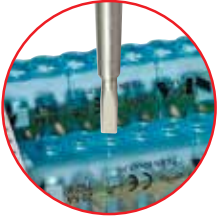

Kapak sökmeden
montaj



Kapak sökmeden
Kablo giriş



Zemine
ve raya montaj

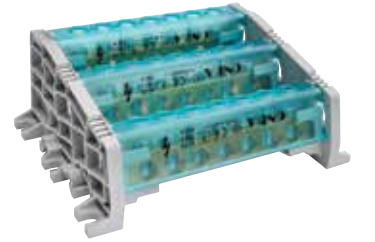
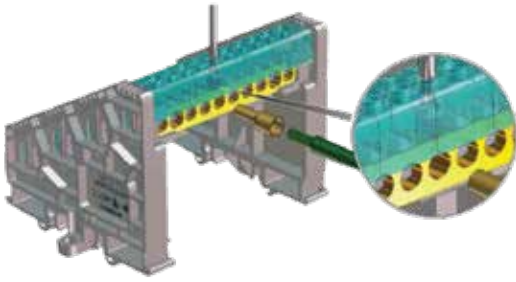

Fiyat Sorunuz



KABLOYÜKSÜKLERİ & UÇLARI

SOLMAZSAN®

TEK GİRİŞLİ İZOLELİ KABLO YÜKSÜKLERİ (BAKIR İLETKEN)



Standart : DIN 46228
Malzeme : Bakır (E-Cu), Kalay Kaplı
İzolasyon : Naylon
Çalışma Sıcaklığı : max.105°C - 600V

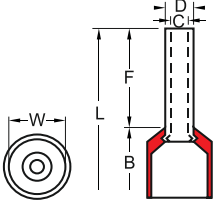

ÜRÜN KODU	RENK	KABLO KESİTİ	ÖLÇÜ						KUTU ADEDİ	₺ / ADET
			F	L	W	B	D	C		
SK 8006	○ ○	0,50 mm	8,0	12,0	2,6	6,3	1,3	1,0	1000	0,188
SK 8010	○ ●	0,75 mm	8,0	14,0	2,8	6,3	1,5	1,2	1000	0,188
SK 8014	● ●	1,00 mm	8,0	14,0	3,0	6,3	1,7	1,4	1000	0,188
SK 8017	● ●	1,50 mm	8,0	14,0	3,5	6,3	2,0	1,7	1000	0,205
SK 8021	● ●	2,50 mm	8,0	14,0	4,2	7,4	2,5	2,2	500	0,263
SK 8025	● ●	4,00 mm	10,0	17,0	4,8	7,4	3,2	2,8	500	0,444
SK 8028	● ●	6,00 mm	12,0	20,0	6,3	8,5	3,9	3,5	250	0,588
SK 8030	● ●	10,0 mm	12,0	22,0	7,6	8,8	4,9	4,5	100	0,743
SK 8032	● ●	16,0 mm	12,0	24,0	8,8	10,0	6,2	5,8	100	1,054
SK 8034	● ●	25,0 mm	16,0	28,0	11,2	12,0	7,7	7,3	50	1,776
SK 8036	● ●	35,0 mm	16,0	30,0	12,7	14,0	8,7	8,3	50	2,220
SK 8039	● ●	50,0 mm	20,0	36,0	15,0	16,0	10,9	10,3	25	4,107
SK 8041	● ●	70,0 mm	20,0	37,0	16,0	17,0	14,3	13,5	10	7,770

ÇİFT GİRİŞLİ İZOLELİ KABLO YÜKSÜKLERİ (BAKIR İLETKEN)



Standart : DIN 46228
Malzeme : Bakır (E-Cu), Kalay Kaplı
İzolasyon : Naylon
Çalışma Sıcaklığı : max.105°C - 600V

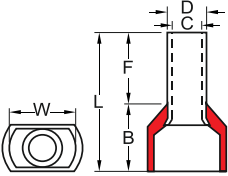

ÜRÜN KODU	RENK	KABLO KESİTİ	ÖLÇÜ						KUTU ADEDİ	₺ / ADET
			F	L	W	B	D	C		
SK 8161	○ ○	2 x 0,50 mm	8,0	14,0	5,0	6,5	1,8	1,5	1000	0,333
SK 8162	○ ●	2 x 0,75 mm	8,0	14,0	5,5	6,7	2,1	1,8	500	0,349
SK 8164	● ●	2 x 1 mm	8,0	14,0	5,5	7,1	2,4	2,1	500	0,371
SK 8166	● ●	2 x 1,5 mm	8,0	14,0	6,4	7,5	2,6	2,3	500	0,449
SK 8168	● ●	2 x 2,5 mm	10,0	14,0	8,0	8,5	3,3	2,9	250	0,732
SK 8170	● ●	2 x 4 mm	12,0	17,0	8,8	11,1	4,2	3,8	200	0,843
SK 8171	● ●	2 x 6 mm	14,0	20,0	9,5	12,1	5,3	4,9	100	1,043
SK 8172	● ●	2 x 10 mm	14,0	27,0	12,6	12,6	6,9	6,5	100	1,665
SK 8173	● ●	2 x 16 mm	14,0	31,0	19,0	17,3	8,7	8,3	50	1,998

İZOLESİZ KABLO YÜKSÜKLERİ (BAKIR İLETKEN)



Standart : DIN 46228
Malzeme : Bakır (E-Cu), Kalay Kaplı

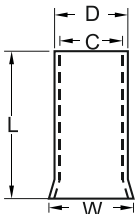

ÜRÜN KODU	KABLO KESİTİ	ÖLÇÜ				KUTU ADEDİ	₺ / ADET
		L	D	C	W		
SK 8100	0,50 mm	10,0	1,3	1,0	1,7	2000	0,188
SK 8101	0,75 mm	10,0	1,3	1,2	1,7	1000	0,188
SK 8102	1 mm	10,0	1,5	1,4	1,9	1000	0,188
SK 8103	1,5 mm	10,0	1,7	1,7	2,2	1000	0,210
SK 8104	2,5 mm	12,0	2,0	2,2	2,5	1000	0,288
SK 8105	4 mm	12,0	2,0	2,8	2,5	1000	0,388
SK 8106	6 mm	12,0	2,6	3,4	3,3	500	0,521
SK 8107	10 mm	15,0	2,6	4,5	3,3	250	0,865
SK 8108	16 mm	15,0	3,2	5,8	3,9	250	1,037
SK 8109	25 mm	16,0	3,9	7,3	4,7	100	1,665
SK 8110	35 mm	16,0	4,9	8,3	5,8	100	1,831
SK 8111	50 mm	20,0	4,9	10,3	5,8	50	3,774



Standart : DIN 46228
Malzeme : Bakır (E-Cu), Kalay Kaplı
İzolasyon : PVC
Çalışma Sıcaklığı : max.105°C - 600V

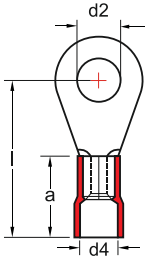

YUVARLAK TİP İZOLELİ KABLO UÇLARI (BAKİR İLETKEN)

ÜRÜN KODU	RENK	KABLO KESİTİ	METRİK VİDA	ÖLÇÜ				KUTU ADEDİ	₺ / ADET
				d2	l	d4	a		
SK 8125	●	0,5 - 1,5	3	3,2	16,0	4,0	10,0	200	0,599
SK 8126	●	0,5 - 1,5	4	4,3	17,0	4,0	10,0	200	0,888
SK 8127	●	0,5 - 1,5	5	5,3	18,0	4,0	10,0	200	0,899
SK 8128	●	0,5 - 1,5	6	6,5	18,0	4,0	10,0	200	1,409
SK 8129	●	0,5 - 1,5	8	8,4	22,0	4,0	10,0	200	1,443
SK 8135	●	1,5 - 2,5	3	3,2	16,0	4,5	10,0	200	1,087
SK 8136	●	1,5 - 2,5	4	4,3	17,0	4,5	10,0	200	1,087
SK 8138	●	1,5 - 2,5	5	5,3	19,0	4,5	10,0	200	1,110
SK 8140	●	1,5 - 2,5	6	6,5	21,0	4,5	10,0	200	1,576
SK 8141	●	1,5 - 2,5	8	8,4	22,0	4,5	10,0	200	1,576
SK 8145	●	4,0 - 6,0	4	4,3	21,0	6,3	13,0	100	2,297
SK 8146	●	4,0 - 6,0	5	5,3	22,0	6,3	13,0	100	2,297
SK 8147	●	4,0 - 6,0	6	6,5	22,5	6,3	13,0	100	2,586
SK 8148	●	4,0 - 6,0	8	8,4	26,0	6,3	13,0	100	3,274
SK 8149	●	4,0 - 6,0	10	10,5	28,0	6,3	13,0	100	3,330
SK 8150	●	4,0 - 6,0	12	13,0	28,0	6,3	13,0	100	3,385

İZOLELİ ÇATAL KABLO UÇLARI (BAKİR İLETKEN)



Standart : DIN 46228
Malzeme : Bakır (E-Cu), Kalay Kaplı
İzolasyon : Naylon
Çalışma Sıcaklığı : max.105°C - 600V

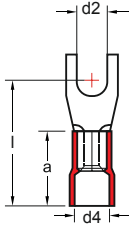

ÜRÜN KODU	RENK	KABLO KESİTİ	METRİK VİDA	ÖLÇÜ				KUTU ADEDİ	₺ / ADET
				d2	l	d4	a		
SK 8064	●	0,5 - 1,5	3	3,2	16,0	4,0	10,0	200	0,793
SK 8065	●	0,5 - 1,5	4	4,3	17,0	4,0	10,0	200	0,832
SK 8066	●	0,5 - 1,5	5	5,3	18,0	4,0	10,0	200	0,843
SK 8067	●	0,5 - 1,5	6	6,5	18,0	4,0	10,0	200	0,954
SK 8072	●	1,5 - 2,5	3	3,2	16,0	4,5	10,0	200	0,876
SK 8073	●	1,5 - 2,5	4	4,3	17,0	4,5	10,0	200	0,899
SK 8074	●	1,5 - 2,5	5	5,3	19,0	4,5	10,0	200	0,910
SK 8075	●	1,5 - 2,5	6	6,5	21,0	4,5	10,0	200	1,221
SK 8078	●	4,0 - 6,0	4	4,3	21,0	6,3	13,0	100	2,000
SK 8079	●	4,0 - 6,0	5	5,3	22,0	6,3	13,0	100	2,020
SK 8080	●	4,0 - 6,0	6	6,5	22,5	6,3	13,0	100	2,740
SK 8081	●	4,0 - 6,0	8	8,4	26,0	6,3	13,0	100	3,108

İZOLELİ FASTON DİŞİ KABLO UÇLARI (PRİNÇ İLETKEN)



Standart : DIN 46237
Malzeme : Piring, Kalay Kaplı
İzolasyon : PVC
Çalışma Sıcaklığı : max.75°C - 300V



ÜRÜN KODU	RENK	KABLO KESİTİ	SOKET GENİŞLİĞİ	ÖLÇÜ					KUTU ADEDİ	₺ / ADET
				W	F	L	B	D		
SK 8232	●	0,5 - 1,5	0,8 x 4,80	5,0	6,4	19,4	10,5	3,8	200	0,732
SK 8234	●	0,5 - 1,5	0,8 x 6,35	6,6	7,5	20,8	10,5	3,8	200	0,943
SK 8235	●	1,5 - 2,5	0,8 x 2,80	5,0	6,4	19,4	10,5	4,7	200	0,752
SK 8239	●	1,5 - 2,5	0,8 x 4,80	5,0	6,4	19,4	10,5	4,7	200	0,832
SK 8240	●	1,5 - 2,5	0,8 x 6,35	6,6	7,5	20,8	10,5	4,7	200	0,943
SK 8243	●	4,0 - 6,0	0,8 x 6,35	6,6	7,5	23,3	13,0	6,2	200	1,165



Malzeme : Pirinç, Kalay Kaplı
İzolasyon : Pvc
Çalışma Sıcaklığı : max.75°C - 300V



İZOLELİ FASTON ERKEK KABLO UÇLARI (PRİNÇ İLETKEN)

ÜRÜN KODU	RENK	KABLO KESİTİ	SOKET GENİŞLİĞİ	ÖLÇÜ					KUTU ADEDİ	₺ / ADET
				W	F	L	B	D		
SK 2229	●	0,5 - 1,5	0,8 x 2,80	6,35	7,7	21,8	10,5	3,8	200	0,666
SK 2224	●	0,5 - 1,5	0,8 x 4,80	4,8	6,7	19,8	10,5	3,8	200	0,666
SK 2225	●	0,5 - 1,5	0,8 x 6,35	6,35	7,7	21,8	10,5	3,8	200	0,788
SK 2226	●	1,5 - 2,5	0,8 x 4,80	4,8	6,7	19,8	10,5	4,7	200	0,666
SK 2227	●	1,5 - 2,5	0,8 x 6,35	6,35	7,7	21,8	10,5	4,7	200	0,865
SK 2228	●	4,0 - 6,0	0,8 x 6,35	6,35	7,7	24,0	13,0	6,2	200	1,032



Malzeme : Pirinç, Kalay Kaplı
İzolasyon : Pvc
Çalışma Sıcaklığı : max.75°C - 300V



TAM İZOLELİ FASTON DIŞI KABLO UÇLARI (PRİNÇ İLETKEN)

ÜRÜN KODU	RENK	KABLO KESİTİ	SOKET GENİŞLİĞİ	ÖLÇÜ					KUTU ADEDİ	₺ / ADET
				W	F	L	B	D		
SK 8250	●	0,5 - 1,5	0,8 x 2,80	3,2	6,5	19,0	10,5	3,8	200	0,865
SK 8252	●	0,5 - 1,5	0,8 x 4,80	5,0	6,4	20,5	10,5	3,8	200	0,965
SK 8254	●	0,5 - 1,5	0,8 x 6,35	6,6	7,5	21,8	10,5	4,7	200	1,276
SK 8257	●	1,5 - 2,5	0,8 x 4,80	3,2	6,5	20,0	10,5	4,7	200	0,976
SK 8259	●	1,5 - 2,5	0,8 x 6,35	5,0	6,4	20,2	10,5	4,7	200	1,276
SK 8260	●	4,0 - 6,0	0,8 x 6,35	6,6	7,5	24,2	12,5	6,2	100	1,387



Malzeme : Pirinç, Kalay Kaplı
İzolasyon : Pvc
Çalışma Sıcaklığı : max.75°C - 300V



İĞNE TİP KABLO UÇLARI (PRİNÇ İLETKEN)

ÜRÜN KODU	RENK	KABLO KESİTİ	SOKET GENİŞLİĞİ	ÖLÇÜ					KUTU ADEDİ	₺ / ADET
				W	F	L	B	D		
SK 2135	●	0,5 - 1,5	1,9	10,0	19,0	10,0	4,0	200	200	0,921
SK 2136	●	1,5 - 2,5	1,9	12,0	21,8	10,0	4,5	200	200	1,110
SK 2137	●	4,0 - 6,0	2,8	14,0	27,0	27,0	6,4	200	200	2,664



Standart : DIN 46237
Malzeme : Bakır, Kalay Kaplı
İzolasyon : Pvc
Çalışma Sıcaklığı : max.75°C - 300V



EK MUFLAR (BAKIR İLETKEN)

ÜRÜN KODU	RENK	KABLO KESİTİ	ÖLÇÜ			KUTU ADEDİ	₺ / ADET
			L	D	d1		
SK 2138	●	0,5 - 1,5	24,6	4,0	1,7	200	1,221
SK 2139	●	1,5 - 2,5	24,6	4,5	2,3	200	1,276
SK 2140	●	4,0 - 6,0	26,5	6,3	3,4	100	2,109

STANDART TERMİNALLER

ÜRÜN KODU	AÇIKLAMA	KOLİ ADEDİ	₺ / ADET
SF-1D	Dişi terminal (6,3)	300	0,754
SF-1/2D	Dişi terminal (2,8)	1000	0,477
SF-1DM	Mini dişi terminal (4,8)	500	0,577
SF-1DE	Dişi-erkek terminal (6,3)	200	1,887
SF-1E ÇK	Erkek terminal (6,3)	300	0,997
SK-2,5-4	Topraklama terminali	1000	0,721
SK-4,0-5	Topraklama terminali	500	1,221
SK-6,0-6	Topraklama terminali	250	1,776
SKN 2,5/4-5-6	Topraklama terminali	500	0,743
SKN 4/4-5-6	Topraklama terminali	250	1,398
SKN 6/6-8	Topraklama terminali	150	2,164
SKN 10/8-10-12-13	Topraklama terminali	100	2,497
SF-1D TK	Terminal kılıfı	300	0,421



SF-1D TK



KABLO BAĞLARI & ETİKETLERİ

SOLMAZSAN®

KABLO BAĞLARI

ÜRÜN KODU	AÇIKLAMA	BAĞLAMA ÇAPI	RENK	KUTU ADEDİ	KOLİ ADEDİ	₺ / ADET
SK 8480	2,5 / 100 kablo bağı	18	Beyaz / Siyah	100	26.000	0,177
SK 8481	2,5 / 150 kablo bağı	35	Beyaz / Siyah	100	20.000	0,277
SK 8482	2,5 / 200 kablo bağı	50	Beyaz / Siyah	100	18.000	0,394
SK 8483	3,6 / 140 kablo bağı	35	Beyaz / Siyah	100	12.000	0,460
SK 8484	3,6 / 200 kablo bağı	50	Beyaz / Siyah	100	10.000	0,604
SK 8485	3,6 / 250 kablo bağı	65	Beyaz / Siyah	100	8.000	0,732
SK 8486	3,6 / 280 kablo bağı	76	Beyaz / Siyah	100	8.000	0,921
SK 8487	3,6 / 370 kablo bağı	102	Beyaz / Siyah	100	6.000	1,165
SK 8489	4,8 / 200 kablo bağı	50	Beyaz / Siyah	100	7.000	0,854
SK 8490	4,8 / 250 kablo bağı	60	Beyaz / Siyah	100	6.000	1,043
SK 8491	4,8 / 300 kablo bağı	76	Beyaz / Siyah	100	5.000	1,276
SK 8492	4,8 / 370 kablo bağı	102	Beyaz / Siyah	100	4.000	1,476
SK 8493	4,8 / 430 kablo bağı	110	Beyaz / Siyah	100	3.000	1,998
SK 8495	7,6 / 300 kablo bağı	76	Beyaz / Siyah	100	3.000	2,519
SK 8496	7,6 / 370 kablo bağı	102	Beyaz / Siyah	100	2.500	2,775
SK 8497	7,6 / 450 kablo bağı	110	Beyaz / Siyah	100	2.000	3,219
SK 8498	7,6 / 550 kablo bağı	140	Beyaz / Siyah	100	1.500	4,275
SK 8499	7,6 / 750 kablo bağı	223	Beyaz / Siyah	100	1.200	6,549
SK 8501	9,0 / 710 kablo bağı	220	Beyaz / Siyah	100	1.200	7,104
SK 8502	9,0 / 760 kablo bağı	236	Beyaz / Siyah	100	1.200	8,547
SK 8503	9,0 / 900 kablo bağı	270	Beyaz / Siyah	100	1.200	9,768

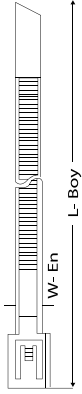

PASLANMAZ ÇELİK KABLO BAĞLARI

ÜRÜN KODU	AÇIKLAMA	BAĞLAMA ÇAPI	RENK	KOLİ ADEDİ	₺ / ADET
SK MTL 150ST	4,6 / 150 kablo bağı	44	Metal	100	2,997
SK MTL 200ST	4,6 / 200 kablo bağı	51		100	3,330
SK MTL 260ST	4,6 / 260 kablo bağı	69		100	3,663
SK MTL 300ST	4,6 / 300 kablo bağı	76		100	3,885
SK MTL 370ST	4,6 / 370 kablo bağı	102		100	4,329
SK MTL 520ST	4,6 / 520 kablo bağı	152		100	5,550
SK MTL 680ST	4,6 / 680 kablo bağı	203		100	6,549
SK MTL 840ST	4,6 / 840 kablo bağı	254		100	7,992
SK MTL 200HD	7,9 / 200 kablo bağı	50	Metal	100	4,773
SK MTL 300HD	7,9 / 300 kablo bağı	75		100	5,328
SK MTL 370HD	7,9 / 370 kablo bağı	102		100	5,994
SK MTL 520HD	7,9 / 520 kablo bağı	152		100	7,730
SK MTL 680HD	7,9 / 680 kablo bağı	203		100	9,990
SK MTL 840HD	7,9 / 840 kablo bağı	224		100	11,100



ETİKETLİ KABLO BAĞLARI

ÜRÜN KODU	AÇIKLAMA	K. ADEDİ	₺ / ADET
GTK 100 MC	100 x 2.5 mm - Beyaz	100	0,499
GTK 190 STC	190 x 4.8 mm - Beyaz	100	1,332



DİSTANSLI KABLO BAĞLARI

ÜRÜN KODU	AÇIKLAMA	K.ADEDİ	₺ / ADET
GTP 100 M	100 x 2.5 mm - Beyaz	100	0,555
GTP 150 I	150 x 3.6 mm - Beyaz	100	0,832
GTP 200 ST	200 x 4.8 mm - Beyaz	100	1,665



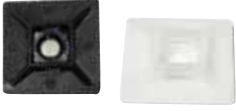

YAPIŞKAN KROŞELER

ÜRÜN KODU	RENK	K. ADEDİ	₺ / ADET
SK 19 x 19	Beyaz / Siyah	100	0,777
SK 28 x 28	Beyaz / Siyah	100	1,332



KABLO KELEPÇESİ

ÜRÜN KODU	AÇIKLAMA	K. ADEDİ	₺ / ADET
GCL 1/4	Beyaz	100	0,555
GCL 3/8	Beyaz	100	0,666



KARTUŞ YÜKSELTİCİ

ÜRÜN KODU	AÇIKLAMA	K. ADEDİ	₺ / ADET
CBS-9A	CBS-9A, Beyaz	1000	0,666
CBS-13A	CBS-13A, Beyaz	1000	0,688



BETON KROŞE

ÜRÜN KODU	AÇIKLAMA	K. ADEDİ	₺ / ADET
TH-2	9.5 x 36 mm - Siyah	100	0,999



VİDALI KROŞE

ÜRÜN KODU	AÇIKLAMA	K. ADEDİ	₺ / ADET
VKV-1	14.9 x 9.5 mm - Beyaz	100	0,566
VKV-2	22.2 x 15.9 mm - Beyaz	100	0,821



KABLO BAĞI ETİKET TAŞIYICI

ÜRÜN KODU	AÇIKLAMA	K. ADEDİ	₺ / ADET
GET-1	35 x 10 x 8 mm - Beyaz	100	1,387
GET-2	45 x 20 x 8 mm - Beyaz	100	2,442



YAPIŞKANLI PANO ETİKETİ

ÜRÜN KODU	AÇIKLAMA	K. ADEDİ	₺ / ADET
GPET-1	30 x 17 x 27.5 mm - Siyah	100	1,609
GPET-2	50 x 17 x 49 mm - Siyah	50	2,164
GPET-3	75 x 17 x 72 mm - Siyah	25	2,941



KABLO İŞARETLEME SİSTEMLERİ

ÜRÜN KODU	ÖLÇÜ	MAKARA	₺ / ADET
EC-0	0,50 - 1 mm kablolar için	1000	62,50
EC-1	1,50 - 6 mm kablolar için	1000	62,50
EC-2	4 - 16 mm kablolar için	500	62,50
EC-3	10 - 25 mm kablolar için	350	62,50



BUTON & AKSESUARLARI

SOLMAZSAN®

YAYLI BUTONLAR

ÜRÜN KODU	AÇIKLAMA	KONTAK	K. ADEDİ	₺ / ADET
SK EA310	Start Buton 22mm	NO	20	38,50
SK EA420	Stop Buton 22mm	NC	20	38,50
SK ED210	0-1 Kalıcı Mandal Buton 22 mm	NC	20	43,50
SK ED330	1-0-2 Kalıcı Mandal Buton 22 mm	NO+NO	20	48,50
SK EA845	İkiz Buton 22 mm	NO+NC	20	87,00
SK ES542	Acil Stop Butonu 22 mm	NC	20	77,00
SK ED410	0-1 Yaylı Mandal Buton 22 mm	NC	20	45,50
SK ED530	1-0-2 Yaylı Mandal Buton 22 mm	NO+NO	20	57,50
SK ZB101	Start Kontak	NO	20	19,50
SK ZB102	Stop Kontak	NC	20	19,50

ÜRÜN KODU	AÇIKLAMA	KONTAK	K. ADEDİ	₺ / ADET
SK A5-10	Start Buton 22mm	NO	10	53,28
SK A5-01	Stop Buton 22mm	NC	10	53,28
SK A5-10X	0-1 Kalıcı Mandal Buton 22 mm	NC	10	61,00
SK A5-20XS	1-0-2 Kalıcı Mandal Buton 22 mm	NO+NO	10	79,90
SK A5-11R	İkiz Buton 22 mm	NO+NC	10	99,90
SK A1-01ZS	Acil Stop Butonu 22 mm	NC	10	122,10
SK A5-10XFU	0-1 Yaylı Mandal Buton 22 mm	NC	10	64,50
SK A5-20XSFU	1-0-2 Yaylı Mandal Buton 22 mm	NO+NO	10	86,50
SK A-10	Start Kontak	NO	10	22,20
SK A-01	Stop Kontak	NC	10	22,20
BR1	Buton Rozeti 22 mm		10	3,22
ER60	Acil Stop (Emergency) Etiketi 22 mm		10	9,80

İŞIKLI YAYLI BUTONLAR

ÜRÜN KODU	AÇIKLAMA	KONTAK	K. ADEDİ	₺ / ADET
SK A5-10D	Start Buton 22 mm - Yeşil Işıklı	1NO	10	97,70
SK A5-01D	Stop Buton 22 mm - Kırmızı Işıklı	1NC	10	97,70
SK A5-10XD	0-1 Mandal Buton 22 mm - Yeşil Işıklı	1NO	10	96,57
SK A5-01XD	0-1 Mandal Buton 22 mm - Kırmızı Işıklı	1NC	10	96,57
SK A5-20XSD	1-0-2 Mandal Buton 22 mm - Yeşil Işıklı	2NO	10	117,50
SK A5-02XSD	1-0-2 Mandal Buton 22 mm - Kırmızı Işıklı	2NC	10	117,50
SK A5-11RD	Işıklı İkiz Buton 22 mm	1NO+1NC	10	138,75

22 mm BUZZER 90 dB

ÜRÜN KODU	AÇIKLAMA	K. ADEDİ	₺ / ADET
AD116-0085	Ledli Buzzer AC 220V Kırmızı	10	79,90
AD116-0084	Ledli Buzzer AC - DC 24V Kırmızı	10	79,90

22 mm POTANSİYOMETRE

ÜRÜN KODU	VOLTAJ	AÇIKLAMA	K. ADEDİ	₺ / ADET
APT22-5K	220V	5K Potansiyometre Tek Tur	10	133,20
APT22-10K	220V	10K Potansiyometre Tek Tur	10	133,20

22 mm LEDLİ SİNYAL LAMBASI



ÜRÜN KODU	RENK	VOLTAJ	AÇIKLAMA	K. ADEDİ	₺ / ADET
SK 22-220Y	●	220V AC	Led Işıklı Sinyal Lambası 22 mm	10	19,98
SK 22-220K	●	220V AC	Led Işıklı Sinyal Lambası 22 mm	10	19,98
SK 22-220S	●	220V AC	Led Işıklı Sinyal Lambası 22 mm	10	19,98
SK 22-220B	○	220V AC	Led Işıklı Sinyal Lambası 22 mm	10	26,50
SK 22-220M	●	220V AC	Led Işıklı Sinyal Lambası 22 mm	10	19,98
SK 22-24Y	●	24V AC-DC	Led Işıklı Sinyal Lambası 22 mm	10	19,98
SK 22-24K	●	24V AC-DC	Led Işıklı Sinyal Lambası 22 mm	10	19,98
SK 22-24S	●	24V AC-DC	Led Işıklı Sinyal Lambası 22 mm	10	19,98

16 mm LEDLİ SİNYAL LAMBASI



ÜRÜN KODU	RENK	VOLTAJ	AÇIKLAMA	K. ADEDİ	₺ / ADET
SK 16-220Y	●	220V AC	Led Işıklı Sinyal Lambası 16 mm	10	29,90
SK 16-220K	●	220V AC	Led Işıklı Sinyal Lambası 16 mm	10	29,90
SK 16-220S	●	220V AC	Led Işıklı Sinyal Lambası 16 mm	10	29,90
SK 16-220B	○	220V AC	Led Işıklı Sinyal Lambası 16 mm	10	39,90
SK 16-220M	●	220V AC	Led Işıklı Sinyal Lambası 16 mm	10	29,90
SK 16-24Y	●	24V AC-DC	Led Işıklı Sinyal Lambası 16 mm	10	29,90
SK 16-24K	●	24V AC-DC	Led Işıklı Sinyal Lambası 16 mm	10	29,90
SK 16-24S	●	24V AC-DC	Led Işıklı Sinyal Lambası 16 mm	10	29,90

10 mm PLASTİK KABLOLU SİNYAL LAMBASI



ÜRÜN KODU	RENK	VOLTAJ	AÇIKLAMA	K. ADEDİ	₺ / ADET
AD22E005R	●	220V	Kablolu Sinyal 10 mm	100	18,75
AD22E005G	●	220V	Kablolu Sinyal 10 mm	100	18,75
AD22E005Y	●	220V	Kablolu Sinyal 10 mm	100	18,75

22 mm VOLTMETRE & AMPERMETRE



ÜRÜN KODU	AÇIKLAMA	K. ADEDİ	₺ / ADET
SK 22-VS-K	22 mm Voltmetre 24-450V - Kırmızı	10	86,60
SK 22-VS-Y	22 mm Voltmetre 24-450V - Yeşil	10	86,60
SK 22-VS-S	22 mm Voltmetre 24-450V - Sarı	10	86,60
SK 22-AS-K	22 mm Ampermetre 100A - Kırmızı	10	161,00
SK 22-AS-Y	22 mm Ampermetre 100A - Yeşil	10	161,00
SK 22-AS-S	22 mm Ampermetre 100A - Sarı	10	161,00
SK 22-VAS-K	22 mm Amper+Volt - Kırmızı	10	302,00
SK 22-VAS-Y	22 mm Amper+Volt - Yeşil	10	302,00
SK 22-VAS-S	22 mm Amper+Volt - Sarı	10	302,00

BOŞ KUMANDA KUTULARI



ÜRÜN KODU	AÇIKLAMA	K. ADEDİ	₺ / ADET
SK-BH100	1'li Boş Kutu	1	35,50
SK-BH200	2'li Boş Kutu	1	44,50
SK-BH300	3'lü Boş Kutu	1	56,60
SK-BH400	4'lü Boş Kutu	1	72,15
SK-BH500	5'li Boş Kutu	1	106,50
SK-BH600	6'lı Boş Kutu	1	106,50
LAY2-KSE542	1'li Mantar Acil Stop Butonu	1	91,00



SİVİÇLER, VİNÇ KUMANDA BUTONLARI & PEDALLAR

SOLMAZSAN®

DOĞRUSAL HAREKETLİ METAL PİM



KOD	CLS101
KUTU ADEDİ	10
ADET / \$	7,43 \$

DOĞRUSAL HAREKETLİ METAL MAKARALI PİM + RESETLİ



KOD	CLS103R
KUTU ADEDİ	10
ADET / \$	7,99 \$

AÇISAL HAREKETLİ 18 mm MAKARALI DÖNER KOL



KOD	CLS121
KUTU ADEDİ	10
ADET / \$	7,43 \$

AÇISAL HAREKETLİ SİRAL TELLİ ÇOK YÖNLÜ KOL



KOD	CLS161
KUTU ADEDİ	10
ADET / \$	7,99 \$

BUTON TAHRİKLİ METAL



KOD	CSA001
KUTU ADEDİ	10
ADET / \$	30,50 \$

METAL MAKARA KOL YATAY



KOD	CSA012
KUTU ADEDİ	10
ADET / \$	30,50 \$

18mm AYARLI SAĞ - SOL METAL MAKARA

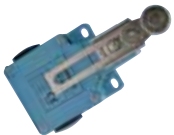

KOD	CSA031
KUTU ADEDİ	10
ADET / \$	30,50 \$

AÇIK KONTAK PANO KAPI SWITCH



KOD	AKS10
KUTU ADEDİ	10
ADET / ₺	39,90

DOĞRUSAL HAREKETLİ METAL MAKARALI PİM



KOD	CLS103
KUTU ADEDİ	10
ADET / \$	7,43 \$

AÇISAL HAREKETLİ 14 mm METAL MAKARALI PİM



KOD	CLS111
KUTU ADEDİ	10
ADET / \$	7,43 \$

AÇISAL HAREKETLİ 18 mm AYARLANABİLİR MAKARALI DÖNER KOL



KOD	CLS131
KUTU ADEDİ	10
ADET / \$	7,99 \$

AÇISAL HAREKETLİ 18 mm AYARLANABİLİR MAKARALI



KOD	CLS191
KUTU ADEDİ	10
ADET / \$	7,99 \$

METAL MAKARA DİKEY



KOD	CSA003
KUTU ADEDİ	10
ADET / \$	30,50 \$

18mm SAĞ - SOL METAL MAKARA



KOD	CSA021
KUTU ADEDİ	10
ADET / \$	30,50 \$

SİRAL TELLİ METAL



KOD	CSA061
KUTU ADEDİ	10
ADET / \$	30,50 \$

KAPALI KONTAK PANO KAPI SWITCH



KOD	AKS01
KUTU ADEDİ	10
ADET / ₺	39,90

MİKRO SİVİÇLER



6811

6812



6813

6814



6815

6817



6818

6819



6820

6821

6822

6823

6824

ÜRÜN KODU	AÇIKLAMA	K. ADEDİ	\$/ ADET
6811	İnce Kısa Pimli 15A 1NO + 1NC	20	3,99 \$
6812	Kalın Uzun Pimli 15A 1NO + 1NC	20	4,44 \$
6813	İnce Uzun Pimli 15A 1NO + 1NC	20	5,10 \$
6814	Uzun Palet 15A 1NO + 1NC	20	4,44 \$
6815	Uzun Palet Metal Makaralı 15A 1NO + 1NC	20	4,77 \$
6817	Kısa Paletli 15A 1NO + 1NC	20	4,44 \$
6818	Kısa Metal Makaralı 15A 1NO + 1NC	20	4,77 \$
6819	Tahrikli Metal Makaralı 15A 1NO + 1NC	20	5,35 \$
6820	Dikey Metal Makaralı 15A 1NO + 1NC	20	6,66 \$
6821	Kalın Kısa Metal Pimli 15A 1NO + 1NC	20	5,77 \$
6822	Yan Dik Metal Makaralı 15A 1NO + 1NC	20	6,66 \$
6823	Uzun Tel Palet 15A 1NO + 1NC	20	4,77 \$
6824	Koruma Kabı	20	0,78 \$

VİNÇ KUMANDA BUTONLARI



ÜRÜN KODU	AÇIKLAMA	K. ADEDİ	\$/ ADET
COB-61	2'li Tek hızlı vinç kumanda butonu	1	6,70 \$
COB-62	4'lü Tek hızlı vinç kumanda butonu	1	8,50 \$
COB-63	6'lı Tek hızlı vinç kumanda butonu	1	11,10 \$
COB-64	8'li Tek hızlı vinç kumanda butonu	1	14,40 \$

ACİL STOPLU VİNÇ KUMANDA BUTONLARI



ÜRÜN KODU	AÇIKLAMA	K. ADEDİ	\$/ ADET
COB-C1	2'li Tek hızlı + acil stoplu vinç kumanda butonu	1	25,50 \$
COB-C2	4'lü Tek hızlı + acil stoplu vinç kumanda butonu	1	35,50 \$
COB-C3	6'lı Tek hızlı + acil stoplu vinç kumanda butonu	1	45,50 \$

AYAK PEDALLARI

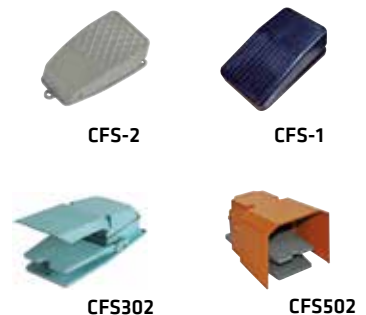

CFS-2

CFS-1

CFS302

CFS502

ÜRÜN KODU	AÇIKLAMA	K. ADEDİ	\$/ ADET
CFS1	Metal ayak pedalı	1	8,88 \$
CFS-2	Metal ayak pedalı	1	12,76 \$
CFS302	Metal ayak pedalı	1	33,00 \$
CFS502	Metal ayak pedalı	1	48,00 \$



MESNET İZOLATÖRLERİ

SOLMAZSAN®

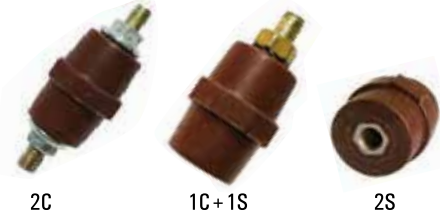

M5 MİNİ İZOLATÖR 25MM

ÜRÜN KODU	AÇIKLAMA	KOLİ AD.	KUTU AD.	₺ / ADET
BMI-M5/2C	Saplamalı İzolatör	1500	100	11,50
BMI-M5/1C+1S	Saplama + Kör Somun İzolatör	1500	100	14,25

M6 ORTA BOY KONİK İZOLATÖR

ÜRÜN KODU	AÇIKLAMA	KOLİ AD.	KUTU AD.	₺ / ADET
BMI-M6/2C	Saplamalı İzolatör	500	100	15,75
BMI-M6/1C+1S	Saplama + Kör Somun İzolatör	500	100	17,85
BMI-M6/2S	Kör Somun İzolatör	500	80	19,95

M8 BÜYÜK BOY FIÇI İZOLATÖR 40mm

ÜRÜN KODU	AÇIKLAMA	KOLİ AD.	KUTU AD.	₺ / ADET
BMI-M8/2C	Saplamalı İzolatör	250	50	26,25
BMI-M8/1C+1S	Saplama + Kör Somun İzolatör	250	50	28,30
BMI-M8/2S	Kör Somun İzolatör	250	50	30,45

M10 BÜYÜK BOY FIÇI İZOLATÖR 40mm

ÜRÜN KODU	AÇIKLAMA	KOLİ AD.	KUTU AD.	₺ / ADET
BMI-M10/2C	Saplamalı İzolatör	200	40	37,80
BMI-M10/1C+1S	Saplama + Kör Somun İzolatör	200	40	39,90
BMI-M10/2S	Kör Somun İzolatör	200	40	42,00

BARA TUTUCU SERFİL (SAC KALINLIĞI 5 mm)

ÜRÜN KODU	AÇIKLAMA	KOLİ AD.	KUTU AD.	₺ / ADET
SERFİL M8	BMI-M 8- M 10	300	50	37,80

1N-500 İZOLATÖRLER

ÜRÜN KODU	AÇIKLAMA	KUTU AD.	₺ / ADET
1NK-500M8	1NK-500 İzolatör M8	80	59,85
1NK-500M10	1NK-500 İzolatör M10	80	71,00
1NK-500M12	1NK-500 İzolatör M12	80	79,80

1N-1000 İZOLATÖRLER

ÜRÜN KODU	AÇIKLAMA	KUTU AD.	₺ / ADET
1NK-1000M12	1NK-1000 İzolatör M12	36	
1NK-1000M16	1NK-1000 İzolatör M16	36	

Fiyat Sorunuz



ÜRÜN KODU	AÇIKLAMA	KUTU AD.	₺ / ADET
3x1F	3x1F Tarak İzolatör	60	39,50



ÜRÜN KODU	AÇIKLAMA	KUTU AD.	₺ / ADET
3x2F	3x2F Tarak İzolatör	48	51,50



ÜRÜN KODU	AÇIKLAMA	KUTU AD.	₺ / ADET
3x1F+N	3x1F+N(4x1F) Tarak İzolatör	30	52,50



ÜRÜN KODU	AÇIKLAMA	KUTU AD.	₺ / ADET
3x2F+N	3x2F+N Tarak İzolatör	30	68,25

MESNET İZOLATÖRÜ (PLASTİK)



Fiyat Sorunuz



PANO AKSESUARLARI & BANTLAR

SOLMAZSAN®

ISIYLA DARALAN MAKARON



ÜRÜN KODU	Ölçüler		Daralmadan Önce (mm)		Daralmadan Sonra (mm)		Makara (m)	Metre Fiyatı (\$)
	İnch	mm	İç Çap	Cidar Kalınlığı	İç Çap	Cidar Kalınlığı		
IDM 1	-	1	2,0 ± 0,3	0,16 ± 0,05	0,70	0,30 ± 0,05	200	0,094 \$
IDM 1,5	-	1,5	2,0 ± 0,3	0,16 ± 0,05	0,80	0,30 ± 0,05	200	0,107 \$
IDM 2	-	2	2,5 ± 0,3	0,16 ± 0,05	1,00	0,35 ± 0,05	200	0,127 \$
IDM 2,4	3/32	2,4	3,0 ± 0,3	0,16 ± 0,05	1,50	0,35 ± 0,05	200	0,127 \$
IDM 2,5	-	2,5	3,0 ± 0,3	0,16 ± 0,05	1,25	0,38 ± 0,05	200	0,166 \$
IDM 3	-	3	3,5 ± 0,4	0,20 ± 0,05	1,50	0,38 ± 0,05	200	0,177 \$
IDM 3,2	1/8	3,2	3,5 ± 0,4	0,20 ± 0,05	1,75	0,40 ± 0,05	200	0,177 \$
IDM 3,5	-	3,5	4,0 ± 0,4	0,20 ± 0,05	1,75	0,40 ± 0,05	200	0,188 \$
IDM 4	-	4	4,5 ± 0,4	0,20 ± 0,05	2,00	0,45 ± 0,05	200	0,222 \$
IDM 4,5	-	4,5	4,8 ± 0,4	0,20 ± 0,05	2,00	0,47 ± 0,08	200	0,255 \$
IDM 4,8	3/16	4,8	5,2 ± 0,4	0,20 ± 0,05	2,60	0,47 ± 0,08	200	0,255 \$
IDM 5	-	5	5,5 ± 0,4	0,20 ± 0,05	2,50	0,55 ± 0,08	200	0,277 \$
IDM 6	-	6	6,5 ± 0,4	0,22 ± 0,05	3,00	0,55 ± 0,08	200	0,321 \$
IDM 6,4	1/4	6,4	7,0 ± 0,4	0,28 ± 0,05	3,50	0,55 ± 0,08	200	0,321 \$
IDM 7	-	7	7,5 ± 0,4	0,28 ± 0,05	3,50	0,60 ± 0,08	100	0,388 \$
IDM 8	-	8	8,5 ± 0,4	0,30 ± 0,08	4,00	0,60 ± 0,08	100	0,388 \$
IDM 9,5	3/8	9,5	10,0 ± 0,5	0,30 ± 0,08	5,00	0,60 ± 0,08	100	0,389 \$
IDM 10	-	10	10,0 ± 0,5	0,30 ± 0,08	5,00	0,60 ± 0,08	100	0,432 \$
IDM 12,7	1/2	12,7	13,0 ± 0,5	0,33 ± 0,10	6,50	0,65 ± 0,08	100	0,499 \$
IDM 13	-	13	13,5 ± 0,5	0,33 ± 0,10	6,50	0,65 ± 0,08	100	0,532 \$
IDM 14	-	14	14,0 ± 0,5	0,33 ± 0,10	7,00	0,70 ± 0,08	100	0,621 \$
IDM 16	-	16	16,5 ± 0,6	0,35 ± 0,12	8,00	0,75 ± 0,08	100	0,830 \$
IDM 18	-	18	19,0 ± 0,6	0,40 ± 0,15	9,00	0,80 ± 0,15	100	1,080 \$
IDM 19,1	3/4	19,1	20,5 ± 0,6	0,40 ± 0,15	10,00	0,80 ± 0,15	100	1,080 \$
IDM 20	4/5	20	20,5 ± 0,6	0,40 ± 0,15	10,00	0,80 ± 0,15	100	1,380 \$
IDM 22	-	22	22,5 ± 0,7	0,45 ± 0,15	12,00	0,95 ± 0,15	100	1,720 \$
IDM 25,4	1	25,4	25,6 ± 0,7	0,45 ± 0,15	12,00	0,95 ± 0,15	50	1,830 \$
IDM 30	-	30	31,5 ± 0,7	0,50 ± 0,15	15,00	0,95 ± 0,15	50	2,380 \$
IDM 32	1-1/4	32	33,0 ± 0,7	0,50 ± 0,15	16,50	0,95 ± 0,15	50	2,380 \$
IDM 35	-	35	38,0 ± 0,7	0,50 ± 0,15	16,00	1,00 ± 0,15	50	2,990 \$
IDM 38	1-1/2	38	40,0 ± 0,7	0,50 ± 0,15	20,00	1,00 ± 0,15	50	3,330 \$
IDM 40	-	40	40,5 ± 0,7	0,50 ± 0,15	20,00	1,00 ± 0,15	50	3,330 \$
IDM 51	2	51	52,5 ± 0,7	0,50 ± 0,15	25,00	1,00 ± 0,15	25	4,210 \$
IDM 60	-	60	60,5 ± 0,8	0,52 ± 0,15	30,00	1,00 ± 0,16	25	5,660 \$
IDM 70	-	70	70,5 ± 1,0	0,55 ± 0,15	40,00	1,10 ± 0,18	25	7,540 \$
IDM 80	-	80	82,0 ± 1,0	0,55 ± 0,15	40,00	1,10 ± 0,18	25	8,320 \$
IDM 102	4	102	105,0 ± 1,0	0,55 ± 0,15	51,00	1,10 ± 0,18	25	10,540 \$
IDM 120	5	120	120,0 ± 1,0	0,55 ± 0,15	60,00	1,10 ± 0,18	25	14,430 \$
IDM 150	-	150	150,0 ± 1,0	0,55 ± 0,15	76,00	1,10 ± 0,18	25	21,000 \$
IDM 180	-	180	180,0 ± 1,0	0,55 ± 0,15	90,00	1,10 ± 0,18	25	29,970 \$

TEKNİK ÖZELLİKLER

Malzeme : Polyolefin
 Daralma Oranı : 2/1
 Yanmazlık : Kendi kendine söner
 Çalışma Sıcaklığı : -55°C -- +125°C



*Renkli makaronlar için fiyat sorunuz.

İÇİ YAPIŞKANLI DARALAN MAKARONLAR



TEKNİK ÖZELLİKLER

Malzeme : Polyolefin
Daralma Oranı : 3/1
Yanmazlık : Kendi kendine söner
Çalışma Sıcaklığı : -55°C -- +125°C

ÜRÜN KODU	Ölçü (mm)	Daralmadan Önce(mm)	Daralmadan Sonra (mm)			Makara (m)	Birim Fiyatı (\$) / Metre
		İç Çap	Çap	Cidar Kalınlığı	Yapışkan Katmanı		
4418	3/1	3	1,00	1,10 ± 0,10	0,50	200	0,720 \$
4419	4,8/1,5	4,8	1,50	1,20 ± 0,10	0,50	100	0,888 \$
4420	6/2	6	2,00	1,30 ± 0,10	0,50	100	1,332 \$
4421	9/3	9	3,00	1,70 ± 0,15	0,60	50	1,776 \$
4405	12/4	12	4,00	2,00 ± 0,20	0,80	1,20 Boy	2,553 \$
4406	16/5	16	5,00	2,20 ± 0,20	0,80	1,20 Boy	3,552 \$
4407	19/6	19	6,00	2,20 ± 0,20	0,80	1,20 Boy	4,995 \$
4408	28/9	28	9,00	2,40 ± 0,20	1,05	1,20 Boy	5,661 \$
4409	33/10	33	10,00	2,50 ± 0,20	1,05	1,20 Boy	6,438 \$
4410	40/12	40	12,00	2,50 ± 0,20	1,05	1,20 Boy	7,104 \$
4411	44/14	44	14,00	2,50 ± 0,20	1,05	1,20 Boy	7,881 \$
4412	52/18	52	18,00	2,50 ± 0,20	1,05	1,20 Boy	8,880 \$
4414	70/25	70	25,00	3,00 ± 0,30	1,35	1,20 Boy	12,540 \$
4415	90/30	90	30,00	3,00 ± 0,30	1,35	1,20 Boy	17,760 \$
4416	125/40	125	40,00	3,00 ± 0,30	1,35	1,20 Boy	22,220 \$

H CLASS CAM ELYAF SİLİKON İZOLELİ MAKARONLAR



ÜRÜN KODU	ÇAP (mm)	METRE	\$ / ADET
IDM 2H	2	200	0,277 \$
IDM 3H	3	100	0,421 \$
IDM 4H	4	100	0,577 \$
IDM 5H	5	100	0,688 \$
IDM 6H	6	100	0,854 \$
IDM 7H	7	100	0,976 \$
IDM 8H	8	50	1,110 \$
IDM 10H	10	50	1,520 \$
IDM 12H	12	50	1,880 \$
IDM 14H	14	50	2,270 \$
IDM 16H	16	25	2,990 \$
IDM 18H	18	25	3,880 \$
IDM 20H	20	25	4,990 \$
IDM 25H	25	25	9,430 \$
IDM 30H	30	25	13,870 \$
IDM 35H	35	25	16,650 \$

KABLO ÇORABI (HALOGEN FREE)



ÜRÜN KODU	AÇIKLAMA	KOLİ ADEDİ	\$/ ADET
KTC 5	Kablo toplama çorabı	100	0,320 \$
KTC 8	Kablo toplama çorabı	100	0,333 \$
KTC 10	Kablo toplama çorabı	100	0,399 \$
KTC 12	Kablo toplama çorabı	100	0,477 \$
KTC 15	Kablo toplama çorabı	100	0,532 \$
KTC 20	Kablo toplama çorabı	100	0,621 \$
KTC 25	Kablo toplama çorabı	100	0,799 \$
KTC 30	Kablo toplama çorabı	50	0,965 \$
KTC 40	Kablo toplama çorabı	50	1,265 \$
KTC 50	Kablo toplama çorabı	25	1,554 \$

HELEZON SİRALLER



ÜRÜN KODU	ÖLÇÜ (cm)	BAÇ	\$/ ADET
SK HS 1	50	100	1,32
SK HS 2	50	100	3,21
SK HS 3	50	100	4,15
SK HS 4	50	50	9,00
SK HS 5	50	50	9,40

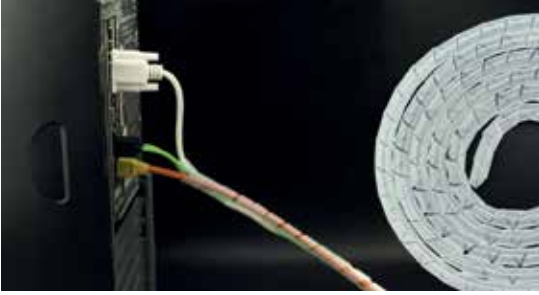

HELEZON SİRALLER RULO

ÜRÜN KODU		Rulo	Paket (mt)	\$/ ADET
3251	No.1	1	10	3,66
3252	No.2	1	10	4,44
3253	No.3	1	10	5,88
3254	No.4	1	10	7,43
3255	No.5	1	10	12,20

BANTLAR



ÜRÜN KODU	AÇIKLAMALAR	KOLİ ADEDİ	\$/ ADET
SK 4801	Eriyen bant (19 mm)	60	
SK 4802	Eriyen bant (50 mm)	24	
SK 4809	İzole bant	500	
SK 4810	Geniş izole bant	36	

Fiyat Sorunuz

PANO İÇİ TERMOSTAT



ÜRÜN KODU	AÇIKLAMALAR	K. ADEDİ	\$/ ADET
ÇTR02K	Isıtma termostatu	1	161,00
ÇTR01M	Soğutma termostatu	1	161,00

RAYA GEÇMELİ PANO PRİZİ



ÜRÜN KODU	AÇIKLAMALAR	K. ADEDİ	\$/ ADET
CP 6801	Ray geçmeli pano prizi - kapaklı	10	84,00

KARE FANLAR



ÜRÜN KODU	ÜRÜN ÖLÇÜLERİ (cm)		KOLİ ADEDİ	\$/ ADET
BRZ 01	120 x 120 x 25	220V AC	1	14,50 \$
BRZ 02	120 x 120 x 38	220V AC	1	14,50 \$
BRZ 04	120 x 120 x 25	12V DC	1	11,00 \$
BRZ 05	120 x 120 x 25	24V DC	1	11,00 \$
BRZ 08	120 x 120 x 38	110V AC	1	13,00 \$
BRZ 14	80 x 80 x 38	220V AC	1	13,00 \$
BRZ 16	80 x 80 x 25	12V DC	1	6,50 \$
BRZ 17	80 x 80 x 25	24V DC	1	6,50 \$
BRZ 21	172 x 150 x 51	220V AC	1	43,00 \$
BRZ 22	172 x 150 x 51	24V DC	1	43,00 \$
BRZ 23	172 x 150 x 51	115V AC	1	43,00 \$

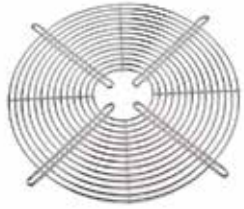

KARE FAN KORUMA TELİ

ÜRÜN KODU	ÜRÜN ÖLÇÜLERİ (cm)		KOLİ ADEDİ	\$/ ADET
TEL 01	80 x 80	fan teli	1	1,20 \$
TEL 03	120 x 120	fan teli	1	1,90 \$
TEL 04	170 x 150	fan teli	1	2,40 \$

SOMUNLU POLYAMİD KABLO RAKORU



ÜRÜN KODU	MONTAJ ÇAPI (mm)	SIKMA ÇAPI (mm)	K. ADEDİ	\$/ ADET
PG 7	13	3-6,5	500	5,10
PG 9	16	4-8	300	5,96
PG 11	19	5-10	200	7,40
PG 13,5	21	6-12	150	8,00
PG 16	23	10-14	125	10,00
PG 21	29	13-18	75	15,80
PG 29	37,5	18-25	40	28,80
PG 36	47,5	22-32	20	49,20
PG 42	54,5	30-38	10	60,50
PG 48	60	34-44	8	68,00

PİRİNÇ KABLO RAKORU (NİKEL KAPLAMA SOMUNLU) IP68)



ÜRÜN KODU	MONTAJ ÇAPI (mm)	SIKMA ÇAPI (mm)	K. ADEDİ	\$/ ADET
PG 7/P	13	3-6,5	50	
PG 9/P	16	4-8	50	
PG 11/P	19	5-10	50	
PG 13,5/P	21	6-12	50	
PG 16/P	23	10-14	25	
PG 21/P	29	13-18	25	
PG 29/P	37,5	18-25	20	
PG 36/P	47,5	22-32	15	
PG 42/P	54,5	30-38	12	
PG 48/P	60	34-44	12	

Fiyat Sorunuz



**ÖLÜM
TEHLİKESİ**



HAVAİ HAT BAĞLANTI KLEMENSLERİ & O.G. SİGORTALAR

SOLMAZSAN®

AL-CU KLEMENSLER



ÜRÜN KODU	SIKMA SAHASI (mm)	İLETKEN	KUTU ADEDİ	₺ / ADET
A25B16 TSE	6-25Al/2,5-16Cu	Rose	100	34,00
A40B25 TSE	16-40Al/10-25Cu	Rose, Lily, Swallow, Sparrow	100	39,70
A70B50 TSE	16-70Al/10-50Cu	Rose, Lily, Swallow, Sparrow	50	70,00
A120B70 TSE	7-120Al/10/70Cu	Pansy, Aster, Phlox, Oxlip, Raven, Pigeon	50	126,20
A240B120 TSE	7-240Al/50-120Cu	Daisy, Peony, Tulip, Canna, Patridge, Ostrich, Hawk	25	295,50
A240B240 TSE	240Al/240Cu	Daisy, Peony, Tulip, Canna, Patridge, Ostrich, Hawk	25	506,25

ALÜMİNYUM PARALEL KLEMENSLER (Branşman-Atlama)



ÜRÜN KODU	SIKMA SAHASI (mm)	İLETKEN	KUTU ADEDİ	₺ / ADET
A16A16 TSE	6-16	Rose	100	20,40
A25A25 TSE	16-25	Rose	50	24,50
A40A40 TSE	16-40	Rose, Lily, Swallow, Sparrow	25	32,50
A70A70 TSE	16-70	Rose, Lily, Pansy, Swallow, Sparrow	50	54,40
A120A120 TSE	40-120	Pansy, Aster, Phlox, Oxlip, Raven	50	92,00
A240A240 TSE	70-240	Daisy, Peony, Tulip, Canna, Patridge, Ostrich, Hawk	50	232,00

DURDURUCU KLEMENSLER



ÜRÜN KODU	SIKMA SAHASI (mm)	İLETKEN	KUTU ADEDİ	₺ / ADET
A16A50 TSE	16-50	Rose, Lily, Swallow, Sparrow	100	47,50
A50A95 TSE	50-95	Rose, Lily, Swallow, Sparrow	50	91,26

İZOLELİ HAVAI HAT KLEMENSİ



ÜRÜN KODU	İLETKEN	KUTU ADEDİ	₺ / ADET
92950	Al 95-35mm, Cu 2,5-50mm	40	70,50
92951	Al 150-50mm, Cu 16-95mm	40	127,00
92954	2'li İzoleli Klemens, Al 150-50mm, Cu 16-95mm	40	254,00

DİREK İÇİ KLEMENS



ÜRÜN KODU	İLETKEN	KUTU ADEDİ	₺ / ADET
92896	Aydınlatma Direk İçi Klemens 1x(1,5-6) 2x(16-35mm)	200	30,50

KABLO BAĞLANTI ÜNİTELERİ



ÜRÜN KODU	İLETKEN	KUTU ADEDİ	₺ / ADET
96951	3 Adet 4x16mm' ye Kadar Kablo Bağlanabilir.	56	250,00

ASKI GERGİ APARATI



ÜRÜN KODU	İLETKEN	KUTU ADEDİ	₺ / ADET
92790	PA20000 Askı Gergi Aparatı Max.70mm	10	344,00

YÜKSEK GERİLİM FAZ GÖSTERGESİ



ÜRÜN KODU	İLETKEN	KUTU ADEDİ	₺ / ADET
78100	CVI Kontaklı IEC	10	999,00
78101	CVI Röleli Kontaklı IEC	10	2.320,00

O.G. SİGORTA



ÜRÜN KODU	AÇIKLAMA	KUTU ADEDİ	₺ / ADET
OGSA61	61 cm O.G. Sigorta (6.....50A) 36kV	12	Fiyat Sorunuz
OGSA51	51 cm O.G. Sigorta (6.....50A) 24kV	12	

TEHLİKE LEVHALARI VE İKAZ ŞERİDİ



ÜRÜN KODU	AÇIKLAMALAR	KOLİ ADEDİ	₺ / ADET
ALM	Tehlike levhası	200	Fiyat Sorunuz
PLS.022	İkaz Şeridi	Kg.	

KONTROL KALEMİ



ÜRÜN KODU	AÇIKLAMALAR	KOLİ ADEDİ	₺ / ADET
SK 158 EKO	Kontrol Kalem	50	21,00

MAKARA İZOLATÖRÜ ve AKSESUARLARI



TAKIM

ÜRÜN KODU	AÇIKLAMA	KUTU ADEDİ	₺ / ADET
BEM0001	Makara İzolatörü	60	Fiyat Sorunuz
BEM0002	İM 22 Mil	60	
BEM0003	ÖD 85 Özengi Demiri	60	
BEM0004	AK 100 Askı Kancası	60	
BEM0008	E-80 İzolatör	90	
BEM0009	E-80 İzolatör Demiri	90	
BEM0010	D-80 Deve Boynu İzolatör Demiri	90	
BEM0011	Makara İzolatör Takım	60	



BEM0001



BEM0003



BEM0002



BEM0004



BEM0010



BEM0009



BEM0008



KAUÇUK FİŞ - PRİZ & AKSESUARLARI & EL ALETLERİ

SOLMAZSAN®

1 x 16 KAUÇUK MONOFAZE ERKEK FİŞ



KOD	SK 2101
KUTU ADEDİ	50
KOLİ ADEDİ	300
ADET / ₺	20,90

1 x 16 KAUÇUK L FİŞ



KOD	SK 2109
KUTU ADEDİ	40
KOLİ ADEDİ	480
ADET / ₺	21,60

1 x 16 KAUÇUK MONOFAZE DIŞI FİŞ



KOD	SK 2103
KUTU ADEDİ	30
KOLİ ADEDİ	240
ADET / ₺	22,50

1 x 16 MONOFAZE TOPRAKLI DUVAR PRİZ



KOD	SK 2104
KUTU ADEDİ	18
KOLİ ADEDİ	108
ADET / ₺	45,90

1 x 16 KAUÇUK MONOFAZE 2'Lİ GRUP PRİZ



KOD	SK 2105
KUTU ADEDİ	8
KOLİ ADEDİ	96
ADET / ₺	65,00

1 x 16 KAUÇUK MONOFAZE 3'LÜ GRUP PRİZ



KOD	SK 2106
KUTU ADEDİ	6
KOLİ ADEDİ	72
ADET / ₺	71,80

1 x 16 KAUÇUK MONOFAZE 4'LÜ GRUP PRİZ



KOD	SK 2107
KUTU ADEDİ	5
KOLİ ADEDİ	50
ADET / ₺	85,00

3 x 25 KAUÇUK TRİFAZE ERKEK FİŞ



KOD	SK 2201
KUTU ADEDİ	30
KOLİ ADEDİ	180
ADET / ₺	52,60

3 x 25 KAUÇUK TRİFAZE DIŞI FİŞ



KOD	SK 2204
KUTU ADEDİ	20
KOLİ ADEDİ	120
ADET / ₺	64,50

3 x 25 KAUÇUK TRİFAZE DUVAR PRİZ



KOD	SK 2205
KUTU ADEDİ	18
KOLİ ADEDİ	108
ADET / ₺	93,00

3 x 25 3'LÜ TRİFAZE GRUP PRİZ



KOD	SK 2213
KUTU ADEDİ	6
KOLİ ADEDİ	36
ADET / ₺	214,50

1 MONOFAZE + 2 TRİFAZE 3'LÜ KAUÇUK PRİZ



KOD	SK 2212
KUTU ADEDİ	6
KOLİ ADEDİ	36
ADET / ₺	212,00

2 MONOFAZE + 1 TRİFAZE 3'LÜ KAUÇUK PRİZ



KOD	SK 2211
KUTU ADEDİ	6
KOLİ ADEDİ	36
ADET / ₺	209,50

TOPRAKLI ERKEK FİŞ

KOD	SK 1201
KUTU ADEDİ	50
KOLİ ADEDİ	600
ADET / ₺	18,80

TOPRAKLI DİŞİ FİŞ

KOD	SK 1202
KUTU ADEDİ	50
KOLİ ADEDİ	600
ADET / ₺	20,00

MİMOZA ERKEK FİŞ

KOD	SK 1203
KUTU ADEDİ	50
KOLİ ADEDİ	950
ADET / ₺	13,50

MİMOZA DİŞİ FİŞ

KOD	SK 1204
KUTU ADEDİ	50
KOLİ ADEDİ	100
ADET / ₺	13,50

TOPRAKLI L FİŞ

KOD	SK 1205
KUTU ADEDİ	50
KOLİ ADEDİ	1000
ADET / ₺	19,80

ARAPUAR

KOD	1207
KUTU ADEDİ	50
KOLİ ADEDİ	1000
ADET / ₺	13,75

3'LÜ GOLYAT FİŞ

KOD	SK 1211
KUTU ADEDİ	50
KOLİ ADEDİ	500
ADET / ₺	57,00

DUY FİŞ

KOD	SK 1209
KUTU ADEDİ	50
KOLİ ADEDİ	500
ADET / ₺	13,75

ANAHTARLI ERKEK FİŞ (IŞIKLI)

KOD	SK 2307
KUTU ADEDİ	50
KOLİ ADEDİ	300
ADET / ₺	49,50

YAĞMUR DUY

KOD	SK 2305
KUTU ADEDİ	50
KOLİ ADEDİ	300
ADET / ₺	14,80

İNGİLİZ ADAPTÖRÜ

KOD	SK 1212
KUTU ADEDİ	50
KOLİ ADEDİ	600
ADET / ₺	31,00

TİJ TAKIMI

KOD	SK 2304
KUTU ADEDİ	50
KOLİ ADEDİ	300
ADET / ₺	19,50

EL ALETLERİ

0,25 - 6 mm² YÜKSÜK SIKMA PENSESİ (GW-B4)

KOD	5026
KUTU ADEDİ	1

73.00 USD

0.08 - 6 mm² YÜKSÜK SIKMA PENSESİ (4 Köşe) (GW-8)

KOD	5008
KUTU ADEDİ	1

99.90 USD

0.50 - 6 mm² İZOLELİ KABLO UCU SIKMA PENSESİ (GW-1)

KOD	5016
KUTU ADEDİ	1

65.50 USD

6 - 50 mm² SKP SIKMA PENSESİ (JY - 0650)

KOD	5045
KUTU ADEDİ	1

91.00 USD

10 - 120 mm² HİDROLİK SKP SIKMA PENSESİ (YOQ 120)

(Çantalı Set)

KOD	5050
KUTU ADEDİ	1

166.50 USD

60 mm² KABLO KESME MAKASI (CC-60)

KOD	5040
KUTU ADEDİ	1

47.70 USD

250 mm² KABLO KESME MAKASI (TC-250)

KOD	5042
KUTU ADEDİ	1

149.50 USD

6 - 16 mm² YÜKSÜK SIKMA PENSESİ (GW - 6)

KOD	5006
KUTU ADEDİ	1

76.50 USD

25 - 35 mm² YÜKSÜK SIKMA PENSESİ (GW - 17)

KOD	5015
KUTU ADEDİ	1

81.00 USD

0.50 - 6 mm² KABLO SIYIRMA PENSESİ (GW - 318)

KOD	5028
KUTU ADEDİ	1

36.50 USD

10 - 120 mm² SKP SIKMA PENSESİ (JY - 06120)

KOD	5046
KUTU ADEDİ	1

183.00 USD

16 - 300 mm² HİDROLİK SKP SIKMA PENSESİ (YQK 300)

(Çantalı Set)

KOD	5051
KUTU ADEDİ	1

177.50 USD

120 mm² KABLO KESME MAKASI (TC-100)

KOD	5041
KUTU ADEDİ	1

79.90 USD

630 mm² KABLO KESME MAKASI (TC-500)

KOD	5044
KUTU ADEDİ	1

216.50 USD



OTOMATİK BASINÇ KONTROL SİSTEMLERİ & FLATÖRLER

SOLMAZSAN®

MONOFAZE BASINÇ ŞALTERİ



ÜRÜN KODU	AÇIKLAMALAR	KOLİ ADEDİ	₺ / ADET
ELT-5	1 - 6 bar tahliyesiz, (1/4" - 1/2")	1	
ELT-5C	1 - 6 bar tahliyeli, (1/4" - 1/2")	1	
ELT-5CO	1 - 6 bar tahliyeli ON/OFF, (1/4" - 1/2")	1	
ELT-5C-3Y	1 - 6 bar tahliyeli, 3 yollu, (1/4" - 1/2")	1	
ELT-5CO-3Y	1 - 6 bar tahliyeli, 3 yollu, ON-OFF, (1/4" - 1/2")	1	
ELT-6	2 - 11 bar tahliyesiz, (1/4" - 1/2")	1	
ELT-6C	2 - 11 bar tahliyeli, (1/4" - 1/2")	1	
ELT-6CO	2 - 11 bar tahliyeli, ON/OFF, (1/4" - 1/2")	1	
ELT-6C-3Y	2 - 11 bar tahliyeli, 3 yollu, (1/4" - 1/2")	1	
ELT-6CO-3Y	2 - 11 bar tahliyeli 3 yollu, ON-OFF, (1/4" - 1/2")	1	

Fiyat Sorunuz

Siparişte alt bağlantı 1/4 veya 1/2 olarak belirtiniz.

TRİFAZE BASINÇ ŞALTERİ



ÜRÜN KODU	AÇIKLAMALAR	KOLİ ADEDİ	₺ / ADET
ELT-2	2 - 8 bar tahliyesiz, (1/4" - 1/2")	1	
ELT-2C	2 - 8 bar tahliyeli, (1/4" - 1/2")	1	
ELT-2CO	2 - 8 bar tahliyeli ON/OFF, (1/4" - 1/2")	1	
ELT-2C-3Y	2 - 8 bar tahliyeli, 3 yollu, (1/4" - 1/2")	1	
ELT-2CO-3Y	2 - 8 bar tahliyeli, 3 yollu, ON-OFF, (1/4" - 1/2")	1	
ELT-3	3 - 11 bar tahliyesiz, (1/4" - 1/2")	1	
ELT-3C	3 - 11 bar tahliyeli, (1/4" - 1/2")	1	
ELT-3CO	3 - 11 bar tahliyeli, ON/OFF, (1/4" - 1/2")	1	
ELT-3C-3Y	3 - 11 bar tahliyeli, 3 yollu, (1/4" - 1/2")	1	
ELT-3CO-3Y	3 - 11 bar tahliyeli 3 yollu, ON-OFF, (1/4" - 1/2")	1	
ELT-4	4 - 16 bar tahliyesiz, (1/4" - 1/2")	1	
ELT-4C	4 - 16 bar tahliyeli, (1/4" - 1/2")	1	
ELT-4CO	4 - 16 bar tahliyeli, ON/OFF, (1/4" - 1/2")	1	
ELT-4C-3Y	4 - 16 bar tahliyeli, 3 yollu, (1/4" - 1/2")	1	
ELT-4CO-3Y	4 - 16 bar tahliyeli, 3 yollu, ON/OFF (1/4" - 1/2")	1	

Fiyat Sorunuz

Siparişte alt bağlantı 1/4 veya 1/2 olarak belirtiniz.

PRESOSTATLAR



ÜRÜN KODU	AÇIKLAMALAR	KOLİ ADEDİ	₺ / ADET
ELT-35	0,2 - 8 bar (1/4" - 7/16")	1	
ELT-36	5 - 16 bar (1/4" - 7/16")	1	

Fiyat Sorunuz

KUYU TİPİ SEVİYE ELEKTROTU



ÜRÜN KODU	AÇIKLAMALAR	KOLİ ADEDİ	₺ / ADET
ELT-E	Kuyu tipi elektrot	25	

Fiyat Sorunuz

TTR KABLOLU SEVİYE FLATÖRÜ

ÜRÜN KODU	AÇIKLAMALAR	KUTU AD.	KOLİ AD.	₺ / ADET
FT-160	1,60 mt. TTR Seviye Flatörü	1	30	Fiyat Sorunuz
FT-300	3 mt. TTR Seviye Flatörü	1	30	
FT-500	5 mt. TTR Seviye Flatörü	1	30	
FT-1000	10 mt. TTR Seviye Flatörü	1	15	
FT-1500	15 mt. TTR Seviye Flatörü	1	15	

KAUÇUK KABLOLU SEVİYE FLATÖRÜ

ÜRÜN KODU	AÇIKLAMALAR	KUTU AD.	KOLİ AD.	₺ / ADET
FT-160K	1,60 mt. Kauçuk Seviye Flatörü	1	30	Fiyat Sorunuz
FT-300K	3 mt. Kauçuk Seviye Flatörü	1	30	
FT-500K	5 mt. Kauçuk Seviye Flatörü	1	30	
FT-1000K	10 mt. Kauçuk Seviye Flatörü	1	15	
FT-1500K	15 mt. Kauçuk Seviye Flatörü	1	15	

90° AÇILI ÇALIŞAN ATIK SIVI SEVİYE FLATÖRÜ

ÜRÜN KODU	AÇIKLAMALAR	KUTU AD.	KOLİ AD.	₺ / ADET
FT-300A	3 mt. Kauçuk Atık Sıvı Seviye Flatörü	1	25	Fiyat Sorunuz
FT-500A	5 mt. Kauçuk Atık Sıvı Seviye Flatörü	1	20	
FT-1000A	10 mt. Kauçuk Atık Sıvı Seviye Flatörü	1	15	
FT-1500A	15 mt. Kauçuk Atık Sıvı Seviye Flatörü	1	15	
FT-2000A	20 mt. Kauçuk Atık Sıvı Seviye Flatörü	1	10	

40° AÇILI ÇALIŞAN ATIK SIVI SEVİYE FLATÖRÜ

ÜRÜN KODU	AÇIKLAMALAR	KUTU AD.	KOLİ AD.	₺ / ADET
FT-300B	3 mt. Kauçuk Atık Sıvı Seviye Flatörü	1	25	Fiyat Sorunuz
FT-500B	5 mt. Kauçuk Atık Sıvı Seviye Flatörü	1	20	
FT-1000B	10 mt. Kauçuk Atık Sıvı Seviye Flatörü	1	15	
FT-1500B	15 mt. Kauçuk Atık Sıvı Seviye Flatörü	1	15	
FT-2000B	20 mt. Kauçuk Atık Sıvı Seviye Flatörü	1	10	

DALGIÇ POMPA KAUÇUK SEVİYE FLATÖRÜ

ÜRÜN KODU	AÇIKLAMALAR	KUTU AD.	KOLİ AD.	₺ / ADET
FT-60K1	0,60 mt. Kauçuk 2x1 mm 7,8 mm H05-RNF	1	25	Fiyat Sorunuz
FT-60K2	0,60 mt. Kauçuk 2x1 mm 9,0 mm H07-RNF	1	20	

BAKIR İLETKENLER İÇİN REÇİNELİ KABLO EK MUFLARI (0.6 - 1 kV)



ŞEFFAF REÇİNELİ KABLO EK MUFLARI (0.6 - 1 kV)



PROTOLİNLER / REÇİNELER



A.G. PABUÇLU REÇ. KAB. BAŞLIKLARI (0.6 - 1 kV)



O.G. 3 DAMARLI HARİCİ İSİ BÜZ. KAB. BAŞ. (20.8-36 kV)



FERMUARLI İSİ BÜZ. KAB. EK MUF (0.6 - 1 kV)



PLASTİK HUNİ KALIPLARI



BAKIR İLETKENLER İÇİN İSİ BÜZÜŞMELİ KABLO EK MUFLARI (0.6 - 1 kV)



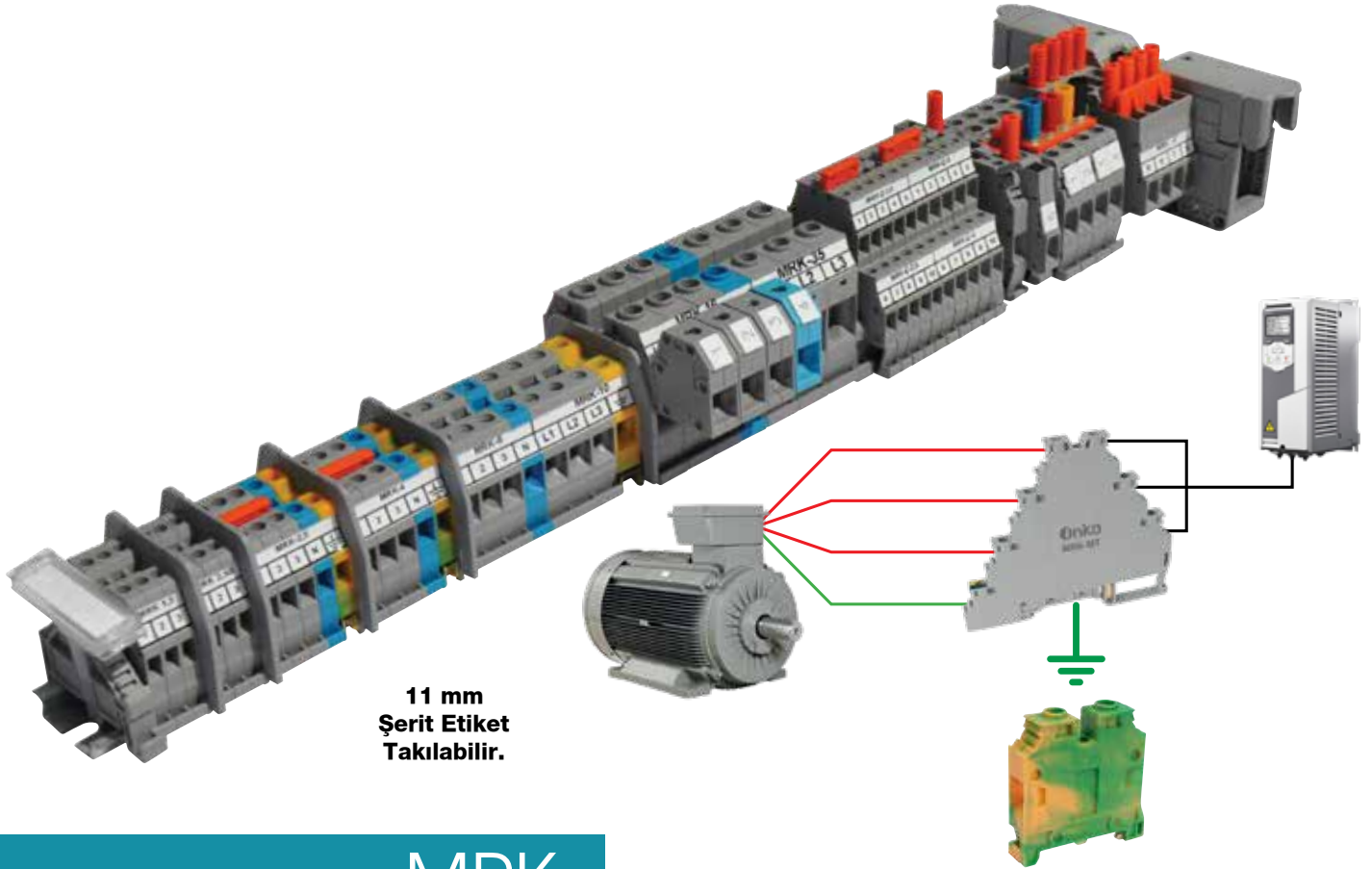

11 mm
Şerit Etiket
Takılabilir.

MRK SERİSİ

Vida Bağlantılı Ray Klemensler

- Nihayet plakası gerektirmez. (Her iki tarafı kapalı)
- Daha iyi bir izolasyon ve maliyet avantajı sağlar.
- Simetrik. (Her iki yönde raya monte edilebilir)
- 0,25 mm² den 240 mm² kablo kesitine kadar montaj imkanı sağlar.
- Renk Kodlama / Dekafix / Şerit Etiketleme olanaklarıyla evrensel markalama avantajları
- Çift yönlü köprüleme imkanı.
- 1,5 mm² den 10 mm² ye kadar izoleli tarak köprü kullanılabilir.
- Vida sistemi 1,5 mm² den 35 mm² ye kadar düz başlı, 50 mm² ve sonraki kesitlerde alyan başlıdır.
- Ergonomik ve kompakt tasarımlara imkan sağlayarak montaj alanını minimize eder.
- MRK Serisi 1.5-2.5-4-6-10-16-25-35-50-70-95-120 mm² kesitlerde üretilmektedir.
- Klemens içerisindeki bakır bara ve kovan iç çeperinde yapılan setler, montajı tamamlanan iletken üzerinde maksimum güvenli bağlantı sağlar.
- MRK 16, 25 ve 35'in köprüleme sistemi vidalı üst köprüdür.

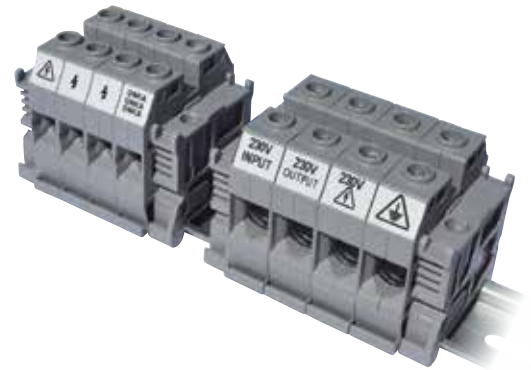

PUSH IN

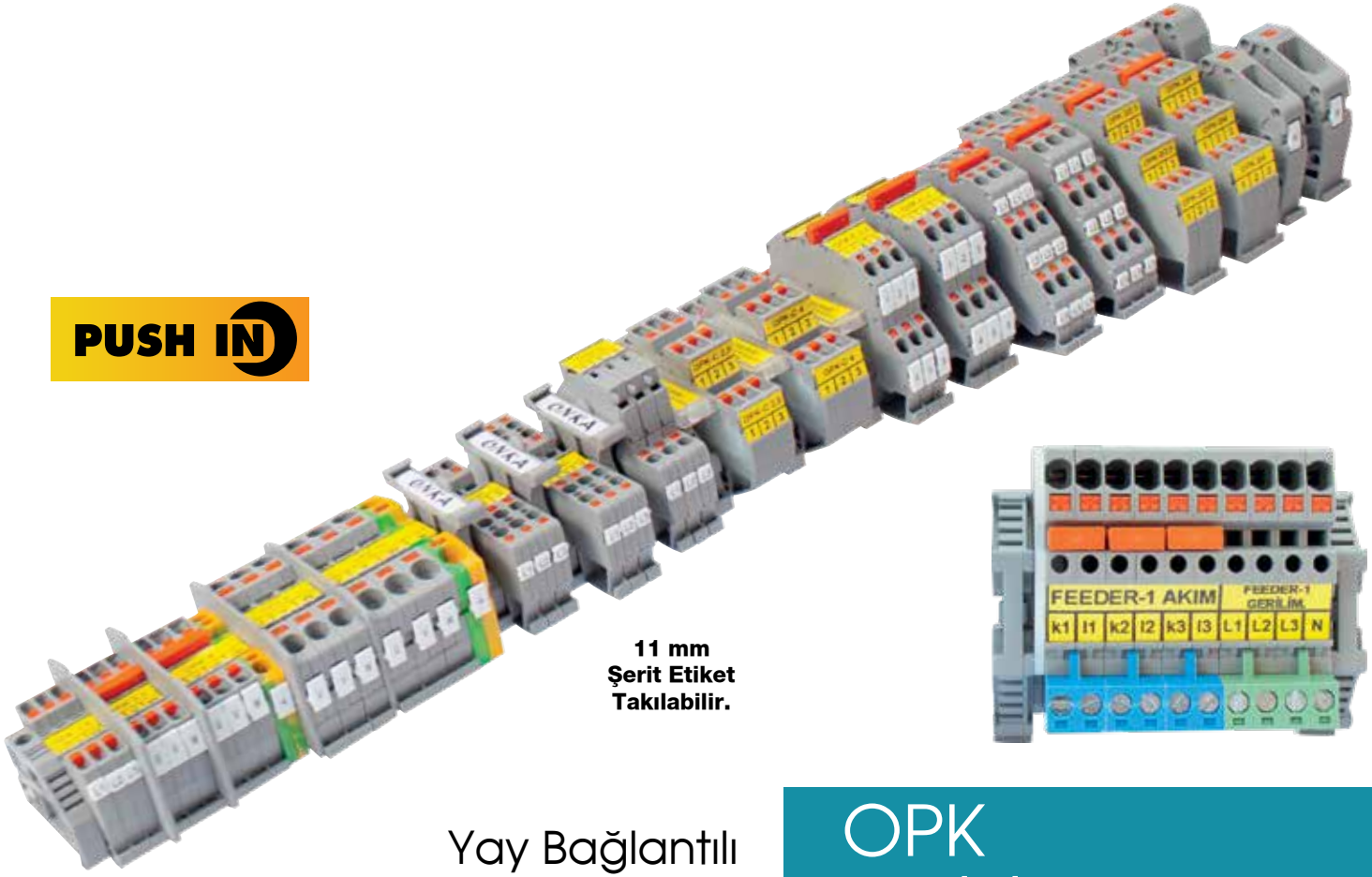

11 mm
Şerit Etiket
Takılabilir.

Yay Bağlantılı Ray Klemensler

OPK SERİSİ

- Push-in Sistem.
- Nihayet plakası gerektirmez. (Her iki tarafı kapalı)
- Daha iyi bir izolasyon ve maliyet avantajı sağlar.
- 1 Katlılar simetrikler. (Her iki yönde raya monte edilebilir)
- Daha düşük kablo itme kuvvetiyle kolay montaj.
- Zaman ve maliyet tasarrufu.
- Yalıtkan butonlar sayesinde montaj esnasında iletken kısma sıfır temas.
- Paslanmaz çelik itici yaylar.
- 0,25 mm² 'den 35 mm² 'ye kadar yüksüklü kablolarda el aleti gerektirmeden montaj imkanı.
- Renk Kodlama / Dekafix / Şerit Etiketleme olanaklarıyla evrensel markalama avantajları

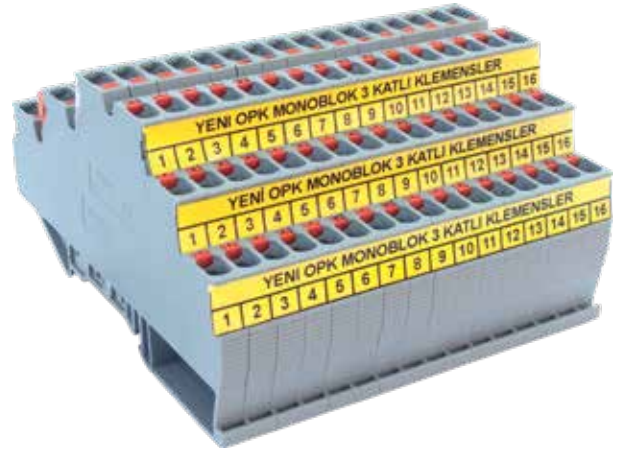



NOTLAR

A series of horizontal dotted lines for writing notes.

SOLMAZSAN®



Perpa Ticaret Merkezi A Blok
Kat: 4-5 No: 215 Okmeydanı / İstanbul
Tel: 0212 222 65 70 Fax: 0212 222 65 80
E-mail: info@solmazsan.com.tr
www.solmazsan.com.tr