

SOLMAZSAN®

FİYAT LİSTESİ

0 c a k 2 0 2 4

www.solmazsan.com.tr

Değerli çözüm ortağımız;

2009 yılında kurulan Solmazsan Elektrik Malzemeleri ve Klemens İmalat San. Tic. Ltd. Şti. enerji sektöründe sahip olduğu bilgi, tecrübe ve deneyimleriyle siz değerli çözüm ortaklarına uygun fiyat ve kaliteli ürün sunmayı ilke edinmiş olup, bu doğrultuda çalışmalarına devam etmektedir.

Güvenilirlik ilkesine bağlı birçok yenilikler ve çalışmalar ortaya koymuş olan firmamız bundan sonraki süreçte de ilkelerinden taviz vermeden alanındaki çalışmalarını genişleterek devam etmeyi hedeflemektedir.

Bizlere bu yolda yardımcı olan siz değerli çözüm ortaklarımız ve bayiliğini yaptığımız firmalara teşekkür ederiz.

Saygılarımızla,

SOLMAZSAN®



İNDEKS

- 4** KABLO PAPUCU ve EK MUFLAR
- 8** BUAT İÇİ BAĞLANTI KLEMENSLERİ
- 11** PANO İÇİ DAĞITIM ve BAĞLANTI KLEMENSLERİ
- 16** KABLO YÜKSÜKLERİ ve UÇLARI
- 20** KABLO BAĞLARI ve ETİKETLERİ
- 23** BUTON ve AKSESUARLARI
- 26** SİVİÇLER, VİNÇ KUMANDA BUTONLARI ve PEDALLAR
- 29** MESNET İZOLATÖRLERİ
- 32** PANO AKSESUARLARI ve BANTLAR
- 37** HAVAI HAT BAĞLANTI KLEMENSLERİ ve O.G. SİGORTALAR
- 40** KAUÇUK FİŞ - PRİZ, AKSESUARLARI ve EL ALETLERİ
- 44** OTOMATİK BASINÇ KONTROL SİSTEMLERİ ve FLATÖRLER
- 47** REÇİNELİ ve ISI BÜZÜŞMELİ KABLO EK MUFLARI

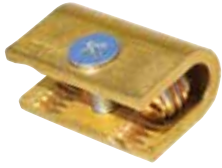

KABLO PAPUCU & EK MUFLAR

SOLMAZSAN®

EKO SKP (Kısa Tip) (BAKIR İLETKEN)

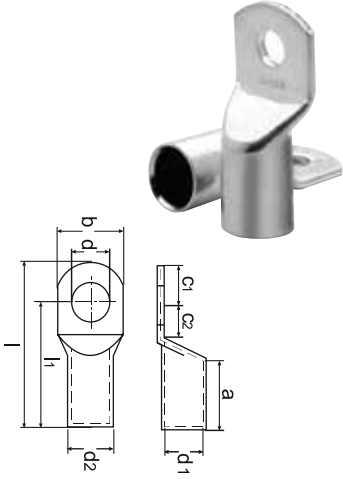

ÜRÜN KODU	KESİT	METRİK	d	d1	d2	l	l1	a	b	c1	c2	K.AD.	₺ / ADET
SK 6027	16 mm ²	M6	6,5	5,6	7,8	29,5	24,0	12,0	11,2	5,5	6,5	500	9,90
SK 6028	25 mm ²	M8	8,5	7,1	9,5	39,0	32,2	16,0	13,7	6,8	9,2	300	16,80
SK 6029	35 mm ²	M8	8,5	8,2	10,8	44,0	35,7	19,0	15,3	8,3	9,7	200	21,80
SK 6030	50 mm ²	M10	10,5	10,1	13,0	51,5	41,5	21,0	18,9	10,0	12,0	125	29,70
SK 6031	70 mm ²	M10	10,5	11,5	14,7	54,6	44,6	23,0	21,1	10,0	12,0	100	46,50
SK 6032	95 mm ²	M12	13,0	13,5	16,7	58,8	49,8	26,0	24,7	10,0	12,0	75	53,50
SK 6033	120 mm ²	M12	13,0	15,6	19,0	69,0	56,0	29,0	27,7	13,0	14,5	50	75,25
SK 6034	150 mm ²	M12	13,0	16,5	21,0	76,5	60,0	30,0	30,4	16,5	16,5	40	108,50
SK 6035	185 mm ²	M16	15,0	18,4	23,0	82,5	65,5	33,0	34,2	17,0	18,0	25	133,50
SK 6036	240 mm ²	M16	15,0	21,0	26,0	89,	72,0	38,0	38,7	17,0	18,0	20	217,50
SK 6037	300 mm ²	M16	16,0	21,0	27,0	91,0	72,0	39,0	40,0	17,0	18,0	20	287,00

STANDART SKP (Uzun ve Kalın Tip) (BAKIR İLETKEN)



ÜRÜN KODU	KESİT	METRİK	d	d1	d2	l	l1	a	b	c1	c2	K.AD.	₺ / ADET
SK 6026/S	10 mm ²	M5	5,5	4,7	6,6	27,5	22,0	10,0	10,3	5,5	7,0	800	10,50
SK 6026/M8	10 mm ²	M8	8,5	4,7	6,6	30,5	23,7	10,0	13,5	6,8	8,7	800	10,50
SK 6027/S	16 mm ²	M6	6,5	5,6	7,8	29,5	24,0	12,0	11,2	5,5	6,5	500	13,80
SK 6027/M8	16 mm ²	M8	8,5	5,6	7,8	33,0	26,2	12,0	13,5	6,8	8,7	500	13,80
SK 6028/S	25 mm ²	M8	8,5	7,1	9,5	39,0	32,2	16,0	13,7	6,8	9,2	275	22,75
SK 6029/S	35 mm ²	M8	8,5	8,2	10,8	44,0	35,7	19,0	15,3	8,3	9,7	175	31,50
SK 6030/S	50 mm ²	M10	10,5	10,1	13,0	51,5	41,5	21,0	18,9	10,0	12,0	100	45,50
SK 6031/S	70 mm ²	M10	10,5	11,5	14,7	54,6	44,6	23,0	21,1	10,0	12,0	90	62,50
SK 6032/S	95 mm ²	M12	13,0	13,5	16,7	58,8	49,8	26,0	24,7	10,0	12,0	60	76,00
SK 6033/S	120 mm ²	M12	13,0	15,6	19,0	69,0	56,0	29,0	27,7	13,0	14,5	50	109,00
SK 6034/S	150 mm ²	M12	13,0	16,5	21,0	76,5	60,0	30,0	30,4	16,5	16,5	30	163,00
SK 6035/S	185 mm ²	M16	15,0	18,4	23,0	82,5	65,5	33,0	34,2	17,0	18,0	25	198,00
SK 6036/S	240 mm ²	M16	15,0	21,0	26,0	89,	72,0	38,0	38,7	17,0	18,0	20	257,50
SK 6037/S	300 mm ²	M16	16,0	21,0	27,0	91,0	72,0	39,0	39,5	17,0	18,0	20	312,00

ALÜMİNYUM SKP (ALÜMİNYUM İLETKEN)

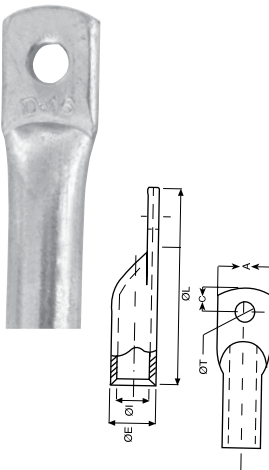

ÜRÜN KODU	KESİT	METRİK	L	K.AD.	₺ / ADET
SKP-AL16	16 mm ²	M6	56	300	8,50
SKP-AL25	25 mm ²	M8	64	150	12,60
SKP-AL35	35 mm ²	M10	73	100	15,50
SKP-AL50	50 mm ²	M10	81	75	20,00
SKP-AL70	70 mm ²	M10	94	50	29,90
SKP-AL95	95 mm ²	M12	102	50	39,10
SKP-AL120	120 mm ²	M12	112	20	44,30
SKP-AL150	150 mm ²	M14	114	20	62,00
SKP-AL185	185 mm ²	M14	125	20	82,50
SKP-AL240	240 mm ²	M14	141	12	103,50

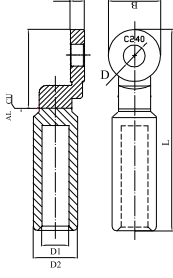

AL-CU SKP (BİMETAL)

ÜRÜN KODU	KESİT	METRİK	L	B	K.AD.	\$/ADET
TBF-16	16 mm ²	M8	84	16	100	3,10
TBF-25	25 mm ²	M8	84	25	100	3,10
TBF-35	35 mm ²	M8	84	35	100	3,30
TBF-50	50 mm ²	M10	84	50	50	4,25
TBF-70	70 mm ²	M10	84	70	50	4,25
TBF-95	95 mm ²	M12	84	95	50	4,35
TBF-120	120 mm ²	M12	107	120	30	7,00
TBF-150	150 mm ²	M12	107	150	30	7,00
TBF-185	185 mm ²	M16	117	185	20	12,00
TBF-240	240 mm ²	M16	117	240	20	12,00

45° AÇILI SKP (BAKIR İLETKEN)



ÜRÜN KODU	KESİT	METRİK	AÇIKLAMA	K.AD.	₺ / ADET
SK-6306	16 mm ²	M6	45° Açılı Kablo Pabucu	200	Fiyat Sorunuz
SK-6307	25 mm ²	M8		100	
SK-6308	35 mm ²	M8		100	
SK-6309	50 mm ²	M10		100	
SK-6310	70 mm ²	M10		50	
SK-6311	95 mm ²	M12		50	
SK-6312	120 mm ²	M12		30	
SK-6313	150 mm ²	M12		20	
SK-6314	185 mm ²	M12		20	
SK-6315	240 mm ²	M12		10	

90° AÇILI SKP (BAKIR İLETKEN)



ÜRÜN KODU	KESİT	METRİK	AÇIKLAMA	K.AD.	₺ / ADET
SK-6316	16 mm ²	M6	90° Açılı Kablo Pabucu	200	Fiyat Sorunuz
SK-6317	25 mm ²	M8		100	
SK-6318	35 mm ²	M8		100	
SK-6319	50 mm ²	M10		100	
SK-6320	70 mm ²	M10		50	
SK-6321	95 mm ²	M12		50	
SK-6322	120 mm ²	M12		30	
SK-6323	150 mm ²	M12		20	
SK-6324	185 mm ²	M12		20	
SK-6325	240 mm ²	M12		10	

ÇİFT DELİKLİ SKP (BAKIR İLETKEN)



ÜRÜN KODU	KESİT	METRİK	AÇIKLAMA	K.AD.	₺ / ADET
SKÇ-6326	16 mm ²	M5/6	Çift Delikli Kablo Pabucu	200	Fiyat Sorunuz
SKÇ-6327	25 mm ²	M8/10		100	
SKÇ-6328	35 mm ²	M8/10		100	
SKÇ-6329	50 mm ²	M8/10		100	
SKÇ-6330	70 mm ²	M10/12		50	
SKÇ-6331	95 mm ²	M10/12/14		50	
SKÇ-6332	120 mm ²	M10/12/14		30	
SKÇ-6333	150 mm ²	M10/12/16		20	
SKÇ-6334	185 mm ²	M10/12/16		20	
SKÇ-6335	240 mm ²	M10/12/16		10	

SEM EK MUFLARI (BAKIR İLETKEN)

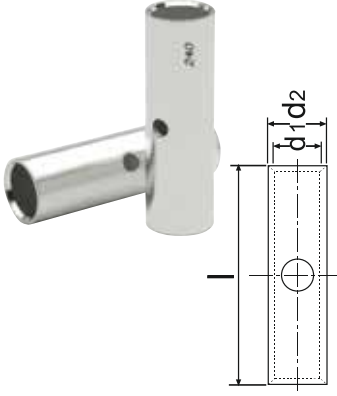

ÜRÜN KODU	KESİT	d1	d2	l	K.AD.	₺ / ADET
SK 7062	16 mm ²	5,6	7,8	32,0	500	11,50
SK 7063	25 mm ²	7,1	9,5	40,5	350	16,50
SK 7064	35 mm ²	8,2	10,8	45,5	200	24,50
SK 7065	50 mm ²	10,1	13,0	53,5	150	27,50
SK 7066	70 mm ²	11,5	14,7	57,5	100	45,00
SK 7067	95 mm ²	13,5	16,7	61,5	80	52,50
SK 7068	120 mm ²	15,6	19,0	74,0	50	75,00
SK 7069	150 mm ²	16,5	21,0	79,0	40	123,00
SK 7070	185 mm ²	18,4	23,0	85,0	30	143,50
SK 7071	240 mm ²	21,0	26,0	94,0	25	201,00

SEM EK MUFLARI (ALÜMİNYUM İLETKEN)

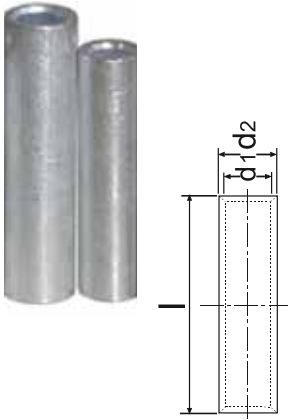

ÜRÜN KODU	KESİT	d1	d2	l	K.AD.	₺ / ADET
SK 7062-A	16 mm ²	5,6	7,8	32,0	200	8,55
SK 7063-A	25 mm ²	7,1	9,5	40,5	125	11,50
SK 7064-A	35 mm ²	8,2	10,8	45,5	100	13,70
SK 7065-A	50 mm ²	10,1	13,0	53,5	75	20,00
SK 7066-A	70 mm ²	11,5	14,7	57,5	50	24,75
SK 7067-A	95 mm ²	13,5	16,7	61,5	40	34,00
SK 7068-A	120 mm ²	15,6	19,0	74,0	25	54,00
SK 7069-A	150 mm ²	16,5	21,0	79,0	20	57,00
SK 7070-A	185 mm ²	18,4	23,0	85,0	15	69,00
SK 7071-A	240 mm ²	21,0	26,0	94,0	15	89,00

U KLEMENSLER



ÜRÜN KODU	AÇIKLAMA	KUTU ADEDİ	₺ / ADET
SK 7050	6 mm ² U klemens	150	21,00
SK 7051	10 mm ² U klemensv	125	28,00
SK 7052	16 mm ² U klemens	100	37,00
SK 7053	25 mm ² U klemens	100	44,00
SK 7054	35 mm ² U klemens	75	47,00
SK 7055	50 mm ² U klemens	50	71,00
SK 7056	70 mm ² U klemens	40	87,00
SK 7057	95 mm ² U klemens	25	121,00
SK 7058	120 mm ² U klemens	20	139,00
SK 7059	150 mm ² U klemens	15	212,00

PORSELEN KLEMENSLER



ÜRÜN KODU	AÇIKLAMA	KUTU ADEDİ	₺ / ADET
SK 601	NO : 1, 2'li lüster	144	18,00
SK 602	NO : 1, 3'lü lüster	80	23,00
SK 603	NO : 2, 2'li lüster	84	23,00
SK 604	NO : 2, 3'lü lüster	48	31,50
SK 605	NO : 3, 2'li lüster	50	31,50
SK 606	NO : 3, 3'lü lüster	30	46,50
SK 607	NO : 1, 1'li lüster	120	16,50
SK 609	NO : 3, 1'li lüster	100	29,00
SK 610	NO : 4, 2'li lüster	40	46,50



BUAT İÇİ BAĞLANTI KLEMENSLERİ

SOLMAZSAN®

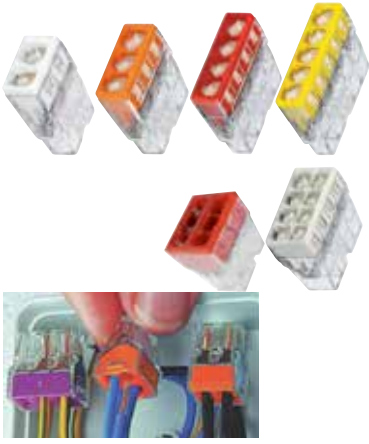

GEÇMELİ BUAT KLEMENSLER

ÜRÜN KODU	KABLO KESİTİ	BAĞLANTI	KUTU ADEDİ	₺ / ADET
SK 8310	2,5 mm ²	2	600	4,60
SK 8311	2,5 mm ²	3	600	4,80
SK 8312	2,5 mm ²	4	300	5,50
SK 8313	2,5 mm ²	5	300	6,50
SK 8315	2,5 mm ²	6	300	8,00
SK 8314	2,5 mm ²	8	200	9,00



AÇ - KAPA BUAT KLEMENSLER

ÜRÜN KODU	KABLO KESİTİ	BAĞLANTI	KUTU ADEDİ	₺ / ADET
SK 8840	2,5 mm ²	2	300	8,15
SK 8842	2,5 mm ²	3	200	10,95
SK 8843	2,5 mm ²	4	150	13,25
SK 8844	2,5 mm ²	5	150	15,90

PLASTİK SIRA KLEMENSLER (EKO) M8 Prinç

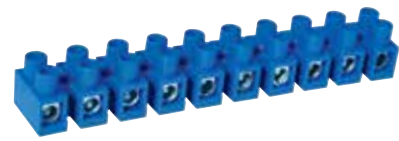

ÜRÜN KODU	BOY	KABLO KESİTİ	BAĞLANTI	AMPER	KUTU ADEDİ	₺ / ADET
SK 101 E	No 1	2,5 - 4 mm ²	12	32	50	46,00
SK 102 E	No 2	4 - 6 mm ²	12	41	50	54,00
SK 103 E	No 3	6 - 10 mm ²	10	57	50	64,00
SK 104 E	No 4	10 - 16 mm ²	6	76	50	76,50
SK 105 E	No 5	16 - 25 mm ²	6	101	50	96,00

ISIYA DAYANIKLI PLASTİK SIRA KLEMENSLER (EKO) M8 Prinç



ÜRÜN KODU	BOY	KABLO KESİTİ	BAĞLANTI	AMPER	KUTU ADEDİ	₺ / ADET
SK 201 E	No 1	2,5 - 4 mm ²	12	32	50	48,00
SK 202 E	No 2	4 - 6 mm ²	12	41	50	56,70
SK 203 E	No 3	6 - 10 mm ²	10	57	50	67,50
SK 204 E	No 4	10 - 16 mm ²	6	76	50	79,50
SK 205 E	No 5	16 - 25 mm ²	6	101	50	99,90



PANO İÇİ DAĞITIM & BAĞLANTI KLEMENSLERİ

SOLMAZSAN®

TRİFAZE MÜŞTEREK W OTOMAT BARASI

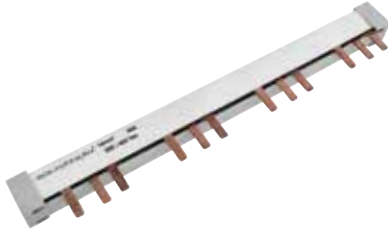

ÜRÜN KODU	ÖLÇÜ	AKIM (A)	MODÜL	KOLİ ADEDİ	₺ / ADET
SK 3043	53 cm	63 (1 mm)	10	25	375,00
SK 3044	53 cm	80 (1 mm)	10	25	420,00
SK 3054	53 cm	125 (1,5 mm)	10	25	630,00
SK 3046	106 cm	63 (1 mm)	20	25	750,00
SK 3045	106 cm	80 (1 mm)	20	25	840,00
SK 3055	106 cm	125 (1,5 mm)	20	25	1.260,00

MONOFAZE MÜŞTEREK W OTOMAT BARASI

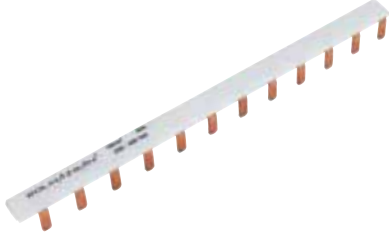

ÜRÜN KODU	ÖLÇÜ	AKIM (A)	MODÜL	KOLİ ADEDİ	₺ / ADET
SK 3003	53 cm	63 (0,8 mm)	30	50	135,00
SK 3004	106 cm	63 (0,8 mm)	60	50	270,00
SK 3005	53 cm	80 (1 mm)	30	50	168,00
SK 3006	106 cm	80 (1 mm)	30	50	336,00
SK 3015	106 cm	125 (1,5 mm)	60	50	441,00

NÖTR TOPRAKLAMA BARASI



ÜRÜN KODU	ÖLÇÜ	AKIM (A)	MODÜL	KOLİ ADEDİ	₺ / ADET
SK 3075	15 x 1,5	100	31	40	470,00
SK 3076	15 x 1,5	100	61	40	570,00
SK 3085	15 x 2,0	100	31	40	600,00
SK 3086	15 x 2,0	100	61	40	690,00

PANO TOPRAKLAMA KLEMENSİ - AYAKSIZ (6 x 8 mm) 63 A

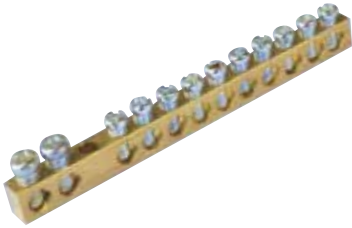

ÜRÜN KODU	AÇIKLAMA	L	B	H	KOLİ ADEDİ	₺ / ADET
SK 1004	2/2 4 delikli	33	6,5	9	100	18,00
SK 1005	2/3 5 delikli	38	6,5	9	100	20,00
SK 1006	2/4 6 delikli	45	6,5	9	100	24,00
SK 1007	2/5 7 delikli	50	6,5	9	100	27,00
SK 1009	2/7 9 delikli	62	6,5	9	100	30,00
SK 1010	2/8 10 delikli	68	6,5	9	100	37,00
SK 1012	2/10 12 delikli	80	6,5	9	100	45,00
SK 1022	2/20 22 delikli	133	6,5	9	50	
SK 909	2/40 42 delikli	274	6,5	9	50	
SK 910	2/60 62 delikli	395	6,5	9	50	
SK 911	2/80 82 delikli	520	6,5	9	50	

Fiyat Sorunuz

PANO TOPRAKLAMA KLEMENSİ - AYAKSIZ (6,5 x 9 mm) 80 A

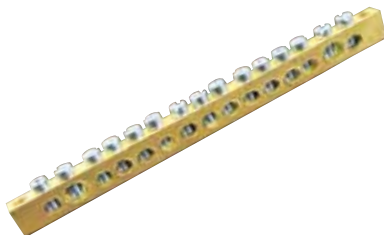

ÜRÜN KODU	AÇIKLAMA	L	L2	B	H	KOLİ ADEDİ	₺ / ADET
SK 1206	6 delikli	65	50	6,5	9	50	40,00
SK 1207	7 delikli	71	56	6,5	9	50	45,00
SK 1210	10 delikli	88	73	6,5	9	50	55,00
SK 1212	12 delikli	100	85	6,5	9	50	57,00
SK 1215	15 delikli	118	103	6,5	9	50	73,00
SK 1220	20 delikli	146	133	6,5	9	50	95,00
SK 1225	25 delikli	177	162	6,5	9	50	127,00
SK 1230	30 delikli	206	191	6,5	9	50	178,00

PANO TOPRAKLAMA KLEMENSİ - AYAKSIZ (7x 12 mm) 125 A



ÜRÜN KODU	AÇIKLAMA	L	L2	B	H	KOLİ ADEDİ	₺ / ADET
SK 1306	6 delikli	65	50	7	12	50	58,00
SK 1307	7 delikli	71	56	7	12	50	61,00
SK 1310	10 delikli	88	73	7	12	50	71,00
SK 1312	12 delikli	100	85	7	12	50	86,00
SK 1315	15 delikli	118	103	7	12	50	114,00
SK 1320	20 delikli	146	133	7	12	50	137,00
SK 1325	25 delikli	177	162	7	12	50	188,00
SK 1330	30 delikli	206	191	7	12	50	244,00

TEK KUTUPLU DAĞITICI ÜNİTE (6,5 x 9 mm) 80 A

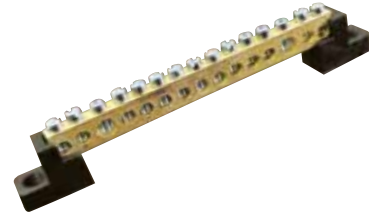

ÜRÜN KODU	AÇIKLAMA	L	L2	H	KOLİ ADEDİ	₺ / ADET
SK 1106/A	6 delikli, ayaklı	100	87	22	50	44,00
SK 1107/A	7 delikli, ayaklı	106	93	22	50	48,00
SK 1110/A	10 delikli, ayaklı	124	100	22	50	59,00
SK 1112/A	12 delikli, ayaklı	135	124	22	50	62,00
SK 1115/A	15 delikli, ayaklı	155	142	22	50	75,00
SK 1120/A	20 delikli, ayaklı	186	173	22	50	96,00
SK 1125/A	25 delikli, ayaklı	218	205	22	50	124,00
SK 1130/A	30 delikli, ayaklı	245	232	22	50	184,00

TEK KUTUPLU DAĞITICI ÜNİTE (7 x 12 mm) 125 A



ÜRÜN KODU	AÇIKLAMA	L	L2	H	KOLİ ADEDİ	₺ / ADET
SK 1306/A	6 delikli, ayaklı	104	70	22	50	59,00
SK 1307/A	7 delikli, ayaklı	104	91	22	50	62,00
SK 1310/A	10 delikli, ayaklı	128	115	22	50	72,00
SK 1312/A	12 delikli, ayaklı	145	130	22	50	87,00
SK 1315/A	15 delikli, ayaklı	162	150	22	50	114,00
SK 1320/A	20 delikli, ayaklı	200	187	22	50	138,00
SK 1325/A	25 delikli, ayaklı	238	225	22	50	185,00
SK 1330/A	30 delikli, ayaklı	275	262	22	50	245,00

EŞ POTANSİYEL BARA 5x20 mm 250A (PLASTİK AYAK)

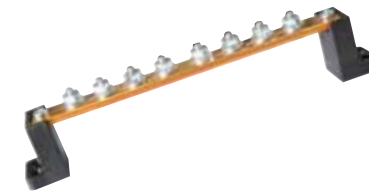

ÜRÜN KODU	AÇIKLAMA	L	B	H	KOLİ ADEDİ	₺ / ADET
SK 3708	1 giriş 7 çıkış	220	-	39	1	505,00
SK 3711	1 giriş 10 çıkış	270	-	39	1	630,00
SK 3715	1 giriş 14 çıkış	345	-	39	1	810,00

EŞ POTANSİYEL BARA 5x20 mm 250A (İZOLATÖR AYAK)

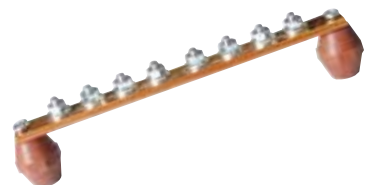

ÜRÜN KODU	AÇIKLAMA	L	B	H	KOLİ ADEDİ	₺ / ADET
SK 3608	1 giriş 7 çıkış	200	-	45	1	576,00
SK 3611	1 giriş 10 çıkış	260	-	45	1	712,00
SK 3615	1 giriş 14 çıkış	335	-	45	1	860,00

2 KUTUPLU DAĞITICI ÜNİTE (6,5 x 9 mm) 80 A



ÜRÜN KODU	AÇIKLAMA	L	B	H	KUTU ADEDİ	₺ / ADET
SK 1407/80	2/5 7 delikli	65	45	47	1	178,50
SK 1410/80	2/8 10 delikli	88	45	47	1	210,00
SK 1412/80	2/10 12 delikli	102	45	47	1	231,00
SK 1415/80	2/13 15 delikli	126	45	47	1	305,00
SK 1420/80	2/18 20 delikli	162	45	47	1	399,00
SK 1422/80	2/20 22 delikli	175	45	47	1	420,00

2 KUTUPLU DAĞITICI ÜNİTE (7 x 12 mm) 125 A

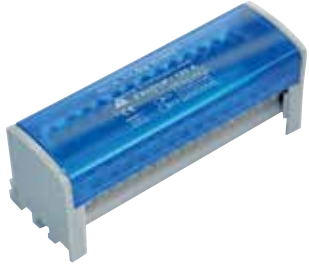

ÜRÜN KODU	AÇIKLAMA	L	B	H	KUTU ADEDİ	₺ / ADET
SK 1407	2/5 7 delikli	65	45	47	1	205,00
SK 1410	2/8 10 delikli	88	45	47	1	228,00
SK 1412	2/10 12 delikli	102	45	47	1	252,00
SK 1415	2/13 15 delikli	126	45	47	1	325,00
SK 1420	2/18 20 delikli	162	45	47	1	420,00
SK 1422	2/20 22 delikli	175	45	47	1	452,00

4 KUTUPLU DAĞITICI ÜNİTE (6,5 x 9 mm) 80 A



ÜRÜN KODU	AÇIKLAMA	L	B	H	KUTU ADEDİ	₺ / ADET
SK 1607/80	2/5 7 delikli	65	45	47	1	410,00
SK 1610/80	2/8 10 delikli	88	45	47	1	430,00
SK 1612/80	2/10 12 delikli	102	45	47	1	493,00
SK 1615/80	2/13 15 delikli	126	45	47	1	593,00
SK 1620/80	2/18 20 delikli	162	45	47	1	745,00
SK 1622/80	2/20 22 delikli	175	45	47	1	767,00

4 KUTUPLU DAĞITICI ÜNİTE (7 x 12 mm) 125 A



ÜRÜN KODU	AÇIKLAMA	L	B	H	KUTU ADEDİ	₺ / ADET
SK 1607	2/5 7 delikli	65	45	47	1	399,00
SK 1610	2/8 10 delikli	88	45	47	1	441,00
SK 1612	2/10 12 delikli	102	45	47	1	488,00
SK 1615	2/13 15 delikli	126	45	47	1	599,00
SK 1620	2/18 20 delikli	162	45	47	1	767,00
SK 1622	2/20 22 delikli	175	45	47	1	830,00

4 KUTUPLU DAĞITICI ÜNİTE (7 x 12 mm) 125 A - YÜKSEK MODEL

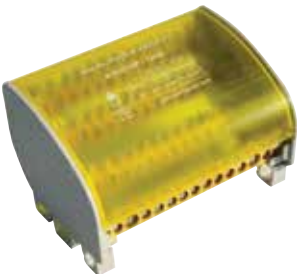

ÜRÜN KODU	AÇIKLAMA	L	B	H	KUTU ADEDİ	₺ / ADET
SK 1507	2/5 7 delikli	65	90	50	1	414,00
SK 1510	2/8 10 delikli	87	90	50	1	450,00
SK 1512	2/10 12 delikli	102	90	50	1	498,00
SK 1515	2/13 15 delikli	126	90	50	1	617,00
SK 1520	2/18 20 delikli	162	90	50	1	802,00
SK 1522	2/20 22 delikli	175	90	50	1	855,00
SK 1525	2/23 25 delikli	197	90	50	1	990,00

4 KUTUPLU DAĞITICI ÜNİTE (10 x 15 mm) 160 A



ÜRÜN KODU	AÇIKLAMA	L	B	H	KUTU ADEDİ	₺ / ADET
SK 160407	2/5 7 delikli	65	90	50	1	735,00
SK 160410	2/8 10 delikli	87	90	50	1	1.050,00
SK 160412	2/10 12 delikli	102	90	50	1	1.250,00
SK 160415	2/13 15 delikli	126	90	50	1	1.550,00
SK 160420	2/18 20 delikli	162	90	50	1	1.950,00
SK 160422	2/20 22 delikli	175	90	50	1	2.100,00
SK 160425	2/23 25 delikli	197	90	50	1	2.350,00

35 x 7,5 mm SAC MONTAJ RAYLARI



ÜRÜN KODU	ÖLÇÜ	AÇIKLAMA	KOLİ ADEDİ	₺ / ADET
SK 4001	30 cm	Düz W otomat rayı	50	12,90
SK 4002	100 cm	Düz W otomat rayı	50	43,00
SK 4003	200 cm	Düz W otomat rayı	25	86,00
SK 4011	30 cm	Delikli W otomat rayı	50	12,90
SK 4012	100 cm	Delikli W otomat rayı	50	43,00
SK 4013	200 cm	Delikli W otomat rayı	25	86,00

*İstenilen ölçüde ray kesilebilir.

Onka®

DAĞITICI
ÜNİTELER

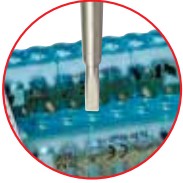

Kapak sökmeden
montaj



Kapak sökmeden
Kablo giriş



Zemine
ve raya montaj

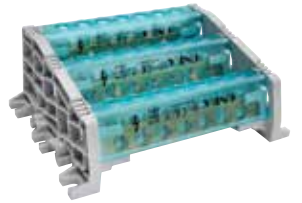
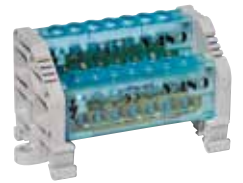
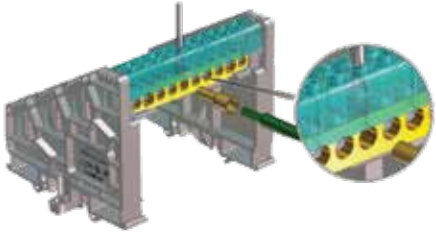



KABLO YÜKSÜKLERİ & UÇLARI

SOLMAZSAN®

TEK GİRİŞLİ İZOLELİ KABLO YÜKSÜKLERİ (BAKIR İLETKEN)



Standart : DIN 46228
Malzeme : Bakır (E-Cu), Kalay Kaplı
İzolasyon : Naylon
Çalışma Sıcaklığı : max.105°C - 600V

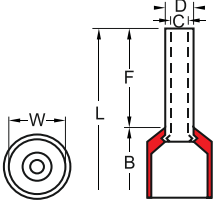

ÜRÜN KODU	RENK	KABLO KESİTİ	ÖLÇÜ						KUTU ADEDİ	₺ / ADET
			F	L	W	B	D	C		
SK 8006	Orange	0,50 mm	8,0	12,0	2,6	6,3	1,3	1,0	1000	0,290
SK 8010	White/Blue	0,75 mm	8,0	14,0	2,8	6,3	1,5	1,2	1000	0,290
SK 8014	Yellow/Red	1,00 mm	8,0	14,0	3,0	6,3	1,7	1,4	1000	0,290
SK 8017	Red/Black	1,50 mm	8,0	14,0	3,5	6,3	2,0	1,7	1000	0,320
SK 8021	Blue/Gray	2,50 mm	8,0	14,0	4,2	7,4	2,5	2,2	500	0,410
SK 8025	Gray/Orange	4,00 mm	10,0	17,0	4,8	7,4	3,2	2,8	500	0,690
SK 8028	Black/Green	6,00 mm	12,0	20,0	6,3	8,5	3,9	3,5	250	0,930
SK 8030	Yellow/Brown	10,0 mm	12,0	22,0	7,6	8,8	4,9	4,5	100	1,180
SK 8032	Green/Yellow	16,0 mm	12,0	24,0	8,8	10,0	6,2	5,8	100	1,640
SK 8034	Brown/Black	25,0 mm	16,0	28,0	11,2	12,0	7,7	7,3	50	2,750
SK 8036	Yellow/Red	35,0 mm	16,0	30,0	12,7	14,0	8,7	8,3	50	3,420
SK 8039	Green/Blue	50,0 mm	20,0	36,0	15,0	16,0	10,9	10,3	25	6,500
SK 8041	Yellow	70,0 mm	20,0	37,0	16,0	17,0	14,3	13,5	10	12,000

ÇİFT GİRİŞLİ İZOLELİ KABLO YÜKSÜKLERİ (BAKIR İLETKEN)



Standart : DIN 46228
Malzeme : Bakır (E-Cu), Kalay Kaplı
İzolasyon : Naylon
Çalışma Sıcaklığı : max.105°C - 600V

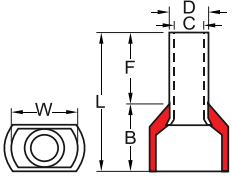

ÜRÜN KODU	RENK	KABLO KESİTİ	ÖLÇÜ						KUTU ADEDİ	₺ / ADET
			F	L	W	B	D	C		
SK 8161	Orange	2 x 0,50 mm	8,0	14,0	5,0	6,5	1,8	1,5	1000	0,520
SK 8162	White/Blue	2 x 0,75 mm	8,0	14,0	5,5	6,7	2,1	1,8	500	0,550
SK 8164	Yellow/Red	2 x 1 mm	8,0	14,0	5,5	7,1	2,4	2,1	500	0,590
SK 8166	Red/Black	2 x 1,5 mm	8,0	14,0	6,4	7,5	2,6	2,3	500	0,710
SK 8168	Blue/Gray	2 x 2,5 mm	10,0	14,0	8,0	8,5	3,3	2,9	250	1,140
SK 8170	Gray/Orange	2 x 4 mm	12,0	17,0	8,8	11,1	4,2	3,8	200	1,320
SK 8171	Black/Green	2 x 6 mm	14,0	20,0	9,5	12,1	5,3	4,9	100	1,640
SK 8172	Yellow/Brown	2 x 10 mm	14,0	27,0	12,6	12,6	6,9	6,5	100	2,520
SK 8173	Green/Yellow	2 x 16 mm	14,0	31,0	19,0	17,3	8,7	8,3	50	3,200

İZOLESİZ KABLO YÜKSÜKLERİ (BAKIR İLETKEN)



Standart : DIN 46228
Malzeme : Bakır (E-Cu), Kalay Kaplı

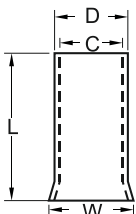

ÜRÜN KODU	KABLO KESİTİ	ÖLÇÜ				KUTU ADEDİ	₺ / ADET
		L	D	C	W		
SK 8100	0,50 mm	10,0	1,3	1,0	1,7	2000	0,300
SK 8101	0,75 mm	10,0	1,3	1,2	1,7	1000	0,300
SK 8102	1 mm	10,0	1,5	1,4	1,9	1000	0,300
SK 8103	1,5 mm	10,0	1,7	1,7	2,2	1000	0,330
SK 8104	2,5 mm	12,0	2,0	2,2	2,5	1000	0,450
SK 8105	4 mm	12,0	2,0	2,8	2,5	1000	0,610
SK 8106	6 mm	12,0	2,6	3,4	3,3	500	0,830
SK 8107	10 mm	15,0	2,6	4,5	3,3	250	1,380
SK 8108	16 mm	15,0	3,2	5,8	3,9	250	1,740
SK 8109	25 mm	16,0	3,9	7,3	4,7	100	2,640
SK 8110	35 mm	16,0	4,9	8,3	5,8	100	3,000
SK 8111	50 mm	20,0	4,9	10,3	5,8	50	6,240

YUVARLAK TİP İZOLELİ KABLO UÇLARI (BAKİR İLETKEN)



Standart : DIN 46228
Malzeme : Bakır (E-Cu), Kalay Kaplı
İzolasyon : PVC
Çalışma Sıcaklığı : max.105°C - 600V

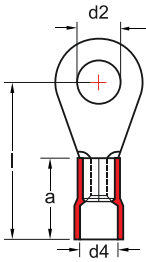

ÜRÜN KODU	RENK	KABLO KESİTİ	METRİK VİDA	ÖLÇÜ				KUTU ADEDİ	₺ / ADET
				d2	l	d4	a		
SK 8125	●	0,5 - 1,5	3	3,2	16,0	4,0	10,0	200	0,940
SK 8126	●	0,5 - 1,5	4	4,3	17,0	4,0	10,0	200	1,400
SK 8127	●	0,5 - 1,5	5	5,3	18,0	4,0	10,0	200	1,420
SK 8128	●	0,5 - 1,5	6	6,5	18,0	4,0	10,0	200	2,250
SK 8129	●	0,5 - 1,5	8	8,4	22,0	4,0	10,0	200	2,250
SK 8135	●	1,5 - 2,5	3	3,2	16,0	4,5	10,0	200	1,740
SK 8136	●	1,5 - 2,5	4	4,3	17,0	4,5	10,0	200	1,740
SK 8138	●	1,5 - 2,5	5	5,3	19,0	4,5	10,0	200	1,760
SK 8140	●	1,5 - 2,5	6	6,5	21,0	4,5	10,0	200	2,500
SK 8141	●	1,5 - 2,5	8	8,4	22,0	4,5	10,0	200	2,500
SK 8145	●	4,0 - 6,0	4	4,3	21,0	6,3	13,0	100	3,700
SK 8146	●	4,0 - 6,0	5	5,3	22,0	6,3	13,0	100	3,700
SK 8147	●	4,0 - 6,0	6	6,5	22,5	6,3	13,0	100	4,200
SK 8148	●	4,0 - 6,0	8	8,4	26,0	6,3	13,0	100	5,400
SK 8149	●	4,0 - 6,0	10	10,5	28,0	6,3	13,0	100	5,450
SK 8150	●	4,0 - 6,0	12	13,0	28,0	6,3	13,0	100	5,550

İZOLELİ ÇATAL KABLO UÇLARI (BAKİR İLETKEN)



Standart : DIN 46228
Malzeme : Bakır (E-Cu), Kalay Kaplı
İzolasyon : Naylon
Çalışma Sıcaklığı : max.105°C - 600V

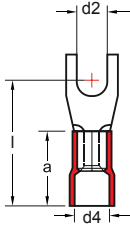

ÜRÜN KODU	RENK	KABLO KESİTİ	METRİK VİDA	ÖLÇÜ				KUTU ADEDİ	₺ / ADET
				d2	l	d4	a		
SK 8064	●	0,5 - 1,5	3	3,2	16,0	4,0	10,0	200	1,280
SK 8065	●	0,5 - 1,5	4	4,3	17,0	4,0	10,0	200	1,320
SK 8066	●	0,5 - 1,5	5	5,3	18,0	4,0	10,0	200	1,380
SK 8067	●	0,5 - 1,5	6	6,5	18,0	4,0	10,0	200	1,560
SK 8072	●	1,5 - 2,5	3	3,2	16,0	4,5	10,0	200	1,440
SK 8073	●	1,5 - 2,5	4	4,3	17,0	4,5	10,0	200	1,480
SK 8074	●	1,5 - 2,5	5	5,3	19,0	4,5	10,0	200	1,500
SK 8075	●	1,5 - 2,5	6	6,5	21,0	4,5	10,0	200	2,00
SK 8078	●	4,0 - 6,0	4	4,3	21,0	6,3	13,0	100	3,250
SK 8079	●	4,0 - 6,0	5	5,3	22,0	6,3	13,0	100	3,300
SK 8080	●	4,0 - 6,0	6	6,5	22,5	6,3	13,0	100	4,400
SK 8081	●	4,0 - 6,0	8	8,4	26,0	6,3	13,0	100	5,150

İZOLELİ FASTON DİŞİ KABLO UÇLARI (PRİNÇ İLETKEN)



Standart : DIN 46237
Malzeme : Pirinç, Kalay Kaplı
İzolasyon : PVC
Çalışma Sıcaklığı : max.75°C - 300V



ÜRÜN KODU	RENK	KABLO KESİTİ	SOKET GENİŞLİĞİ	ÖLÇÜ					KUTU ADEDİ	₺ / ADET
				W	F	L	B	D		
SK 8232	●	0,5 - 1,5	0,8 x 4,80	5,0	6,4	19,4	10,5	3,8	200	1,150
SK 8234	●	0,5 - 1,5	0,8 x 6,35	6,6	7,5	20,8	10,5	3,8	200	1,470
SK 8235	●	1,5 - 2,5	0,8 x 2,80	5,0	6,4	19,4	10,5	4,7	200	1,150
SK 8239	●	1,5 - 2,5	0,8 x 4,80	5,0	6,4	19,4	10,5	4,7	200	1,200
SK 8240	●	1,5 - 2,5	0,8 x 6,35	6,6	7,5	20,8	10,5	4,7	200	1,700
SK 8243	●	4,0 - 6,0	0,8 x 6,35	6,6	7,5	23,3	13,0	6,2	200	1,700



Malzeme : Pirinç, Kalay Kaplı
İzolasyon : Pvc
Çalışma Sıcaklığı : max.75°C - 300V



İZOLELİ FASTON ERKEK KABLO UÇLARI (PRİNÇ İLETKEN)

ÜRÜN KODU	RENK	KABLO KESİTİ	SOKET GENİŞLİĞİ	ÖLÇÜ					KUTU ADEDİ	₺ / ADET
				W	F	L	B	D		
SK 2229	●	0,5 - 1,5	0,8 x 2,80	6,35	7,7	21,8	10,5	3,8	200	0,950
SK 2224	●	0,5 - 1,5	0,8 x 4,80	4,8	6,7	19,8	10,5	3,8	200	1,080
SK 2225	●	0,5 - 1,5	0,8 x 6,35	6,35	7,7	21,8	10,5	3,8	200	1,380
SK 2226	●	1,5 - 2,5	0,8 x 4,80	4,8	6,7	19,8	10,5	4,7	200	1,200
SK 2227	●	1,5 - 2,5	0,8 x 6,35	6,35	7,7	21,8	10,5	4,7	200	1,440
SK 2228	●	4,0 - 6,0	0,8 x 6,35	6,35	7,7	24,0	13,0	6,2	200	1,700



Malzeme : Pirinç, Kalay Kaplı
İzolasyon : Pvc
Çalışma Sıcaklığı : max.75°C - 300V



TAM İZOLELİ FASTON DIŞI KABLO UÇLARI (PRİNÇ İLETKEN)

ÜRÜN KODU	RENK	KABLO KESİTİ	SOKET GENİŞLİĞİ	ÖLÇÜ					KUTU ADEDİ	₺ / ADET
				W	F	L	B	D		
SK 8250	●	0,5 - 1,5	0,8 x 2,80	3,2	6,5	19,0	10,5	3,8	200	1,440
SK 8252	●	0,5 - 1,5	0,8 x 4,80	5,0	6,4	20,5	10,5	3,8	200	1,700
SK 8254	●	0,5 - 1,5	0,8 x 6,35	6,6	7,5	21,8	10,5	4,7	200	2,000
SK 8257	●	1,5 - 2,5	0,8 x 4,80	3,2	6,5	20,0	10,5	4,7	200	1,750
SK 8259	●	1,5 - 2,5	0,8 x 6,35	5,0	6,4	20,2	10,5	4,7	200	2,100
SK 8260	●	4,0 - 6,0	0,8 x 6,35	6,6	7,5	24,2	12,5	6,2	100	2,400



Malzeme : Pirinç, Kalay Kaplı
İzolasyon : Pvc
Çalışma Sıcaklığı : max.75°C - 300V



İĞNE TİP KABLO UÇLARI (PRİNÇ İLETKEN)

ÜRÜN KODU	RENK	KABLO KESİTİ	SOKET GENİŞLİĞİ	ÖLÇÜ					KUTU ADEDİ	₺ / ADET
				W	F	L	B	D		
SK 2135	●	0,5 - 1,5	1,9	10,0	19,0	10,0	4,0	200	200	1,500
SK 2136	●	1,5 - 2,5	1,9	12,0	21,8	10,0	4,5	200	200	1,800
SK 2137	●	4,0 - 6,0	2,8	14,0	27,0	27,0	6,4	200	200	4,300



Standart : DIN 46237
Malzeme : Bakır, Kalay Kaplı
İzolasyon : Pvc
Çalışma Sıcaklığı : max.75°C - 300V



EK MUFLAR (BAKIR İLETKEN)

ÜRÜN KODU	RENK	KABLO KESİTİ	ÖLÇÜ			KUTU ADEDİ	₺ / ADET
			L	D	d1		
SK 2138	●	0,5 - 1,5	24,6	4,0	1,7	200	2,000
SK 2139	●	1,5 - 2,5	24,6	4,5	2,3	200	2,000
SK 2140	●	4,0 - 6,0	26,5	6,3	3,4	100	3,400

STANDART TERMİNALLER

ÜRÜN KODU	AÇIKLAMA	KOLİ ADEDİ	₺ / ADET
SF-1D	Dişi terminal (6,3)	300	1,100
SF-1/2D	Dişi terminal (2,8)	1000	0,720
SF-1DM	Mini dişi terminal (4,8)	500	0,860
SF-1DE	Dişi-erkek terminal (6,3)	200	2,750
SF-1E ÇK	Erkek terminal (6,3)	300	1,420
SK-2,5-4	Topraklama terminali	1000	1,000
SK-4,0-5	Topraklama terminali	500	1,680
SK-6,0-6	Topraklama terminali	250	2,500
SKN 2,5/4-5-6	Topraklama terminali	500	1,100
SKN 4/4-5-6	Topraklama terminali	250	2,000
SKN 6/6-8	Topraklama terminali	150	3,130
SKN 10/8-10-12-13	Topraklama terminali	100	3,550
SF-1D TK	Terminal kılıfı	300	0,600





KABLO BAĞLARI & ETİKETLERİ

SOLMAZSAN®

KABLO BAĞLARI

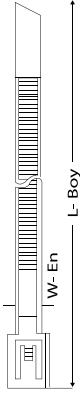

ÜRÜN KODU	AÇIKLAMA	BAĞLAMA ÇAPI	RENK	KUTU ADEDİ	KOLİ ADEDİ	₺ / ADET
SK 8480	2,5 / 100 kablo bağı	18	Beyaz / Siyah	100	26.000	0,230
SK 8481	2,5 / 150 kablo bağı	35	Beyaz / Siyah	100	20.000	0,350
SK 8482	2,5 / 200 kablo bağı	50	Beyaz / Siyah	100	18.000	0,510
SK 8483	3,6 / 140 kablo bağı	35	Beyaz / Siyah	100	12.000	0,600
SK 8484	3,6 / 200 kablo bağı	50	Beyaz / Siyah	100	10.000	0,780
SK 8485	3,6 / 250 kablo bağı	65	Beyaz / Siyah	100	8.000	0,940
SK 8486	3,6 / 280 kablo bağı	76	Beyaz / Siyah	100	8.000	1,190
SK 8487	3,6 / 370 kablo bağı	102	Beyaz / Siyah	100	6.000	1,500
SK 8489	4,8 / 200 kablo bağı	50	Beyaz / Siyah	100	7.000	1,110
SK 8490	4,8 / 250 kablo bağı	60	Beyaz / Siyah	100	6.000	1,360
SK 8491	4,8 / 300 kablo bağı	76	Beyaz / Siyah	100	5.000	1,640
SK 8492	4,8 / 370 kablo bağı	102	Beyaz / Siyah	100	4.000	1,900
SK 8493	4,8 / 430 kablo bağı	110	Beyaz / Siyah	100	3.000	2,550
SK 8495	7,6 / 300 kablo bağı	76	Beyaz / Siyah	100	3.000	3,250
SK 8496	7,6 / 370 kablo bağı	102	Beyaz / Siyah	100	2.500	3,660
SK 8497	7,6 / 450 kablo bağı	110	Beyaz / Siyah	100	2.000	4,350
SK 8498	7,6 / 550 kablo bağı	140	Beyaz / Siyah	100	1.500	5,600
SK 8499	7,6 / 750 kablo bağı	223	Beyaz / Siyah	100	1.200	8,400
SK 8501	9,0 / 710 kablo bağı	220	Beyaz / Siyah	100	1.200	9,150
SK 8502	9,0 / 760 kablo bağı	236	Beyaz / Siyah	100	1.200	11,200
SK 8503	9,0 / 900 kablo bağı	270	Beyaz / Siyah	100	1.200	12,500

PASLANMAZ ÇELİK KABLO BAĞLARI



ÜRÜN KODU	AÇIKLAMA	BAĞLAMA ÇAPI	RENK	KOLİ ADEDİ	₺ / ADET
SK MTL 150ST	4,6 / 150 kablo bağı	44	Metal	100	3,880
SK MTL 200ST	4,6 / 200 kablo bağı	51		100	4,350
SK MTL 260ST	4,6 / 260 kablo bağı	69		100	4,880
SK MTL 300ST	4,6 / 300 kablo bağı	76		100	5,210
SK MTL 370ST	4,6 / 370 kablo bağı	102		100	5,770
SK MTL 520ST	4,6 / 520 kablo bağı	152		100	7,200
SK MTL 680ST	4,6 / 680 kablo bağı	203		100	8,850
SK MTL 840ST	4,6 / 840 kablo bağı	254		100	10,500
SK MTL 200HD	7,9 / 200 kablo bağı	50	Metal	100	6,700
SK MTL 300HD	7,9 / 300 kablo bağı	75		100	7,700
SK MTL 370HD	7,9 / 370 kablo bağı	102		100	9,100
SK MTL 520HD	7,9 / 520 kablo bağı	152		100	11,400
SK MTL 680HD	7,9 / 680 kablo bağı	203		100	13,300
SK MTL 840HD	7,9 / 840 kablo bağı	224		100	16,650

ETİKETLİ KABLO BAĞLARI



ÜRÜN KODU	AÇIKLAMA	K. ADEDİ	₺ / ADET
GTK 100 MC	100 x 2.5 mm - Beyaz	100	0,730
GTK 190 STC	190 x 4.8 mm - Beyaz	100	1,700

DİSTANSLI KABLO BAĞLARI



ÜRÜN KODU	AÇIKLAMA	K.ADEDİ	₺ / ADET
GTP 100 M	100 x 2.5 mm - Beyaz	100	0,720
GTP 150 I	150 x 3.6 mm - Beyaz	100	1,050
GTP 200 ST	200 x 4.8 mm - Beyaz	100	2,220

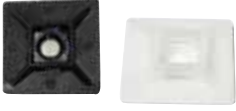

YAPIŞKAN KROŞELER

ÜRÜN KODU	RENK	K. ADEDİ	₺ / ADET
SK 19 x 19	Beyaz / Siyah	100	1,000
SK 28 x 28	Beyaz / Siyah	100	1,780



KABLO KELEPÇESİ

ÜRÜN KODU	AÇIKLAMA	K. ADEDİ	₺ / ADET
GCL 1/4	Beyaz	100	0,720
GCL 3/8	Beyaz	100	0,860



KARTUŞ YÜKSELTİCİ

ÜRÜN KODU	AÇIKLAMA	K. ADEDİ	₺ / ADET
CBS-9A	CBS-9A, Beyaz	1000	0,860
CBS-13A	CBS-13A, Beyaz	1000	0,880



BETON KROŞE

ÜRÜN KODU	AÇIKLAMA	K. ADEDİ	₺ / ADET
TH-2	9.5 x 36 mm - Siyah	100	1,300



VİDALI KROŞE

ÜRÜN KODU	AÇIKLAMA	K. ADEDİ	₺ / ADET
VKV-1	14.9 x 9.5 mm - Beyaz	100	0,740
VKV-2	22.2 x 15.9 mm - Beyaz	100	1,070



KABLO BAĞI ETİKET TAŞIYICI

ÜRÜN KODU	AÇIKLAMA	K. ADEDİ	₺ / ADET
GET-1	35 x 10 x 8 mm - Beyaz	100	1,770
GET-2	45 x 20 x 8 mm - Beyaz	100	3,100



YAPIŞKANLI PANO ETİKETİ

ÜRÜN KODU	AÇIKLAMA	K. ADEDİ	₺ / ADET
GPET-1	30 x 17 x 27.5 mm - Siyah	100	2,100
GPET-2	50 x 17 x 49 mm - Siyah	50	2,770
GPET-3	75 x 17 x 72 mm - Siyah	25	3,770



KABLO İŞARETLEME SİSTEMLERİ

ÜRÜN KODU	ÖLÇÜ	MAKARA	₺ / ADET
EC-0	0,50 - 1 mm kablolar için	1000	98,00
EC-1	1,50 - 6 mm kablolar için	1000	98,00
EC-2	4 - 16 mm kablolar için	500	98,00
EC-3	10 - 25 mm kablolar için	350	98,00

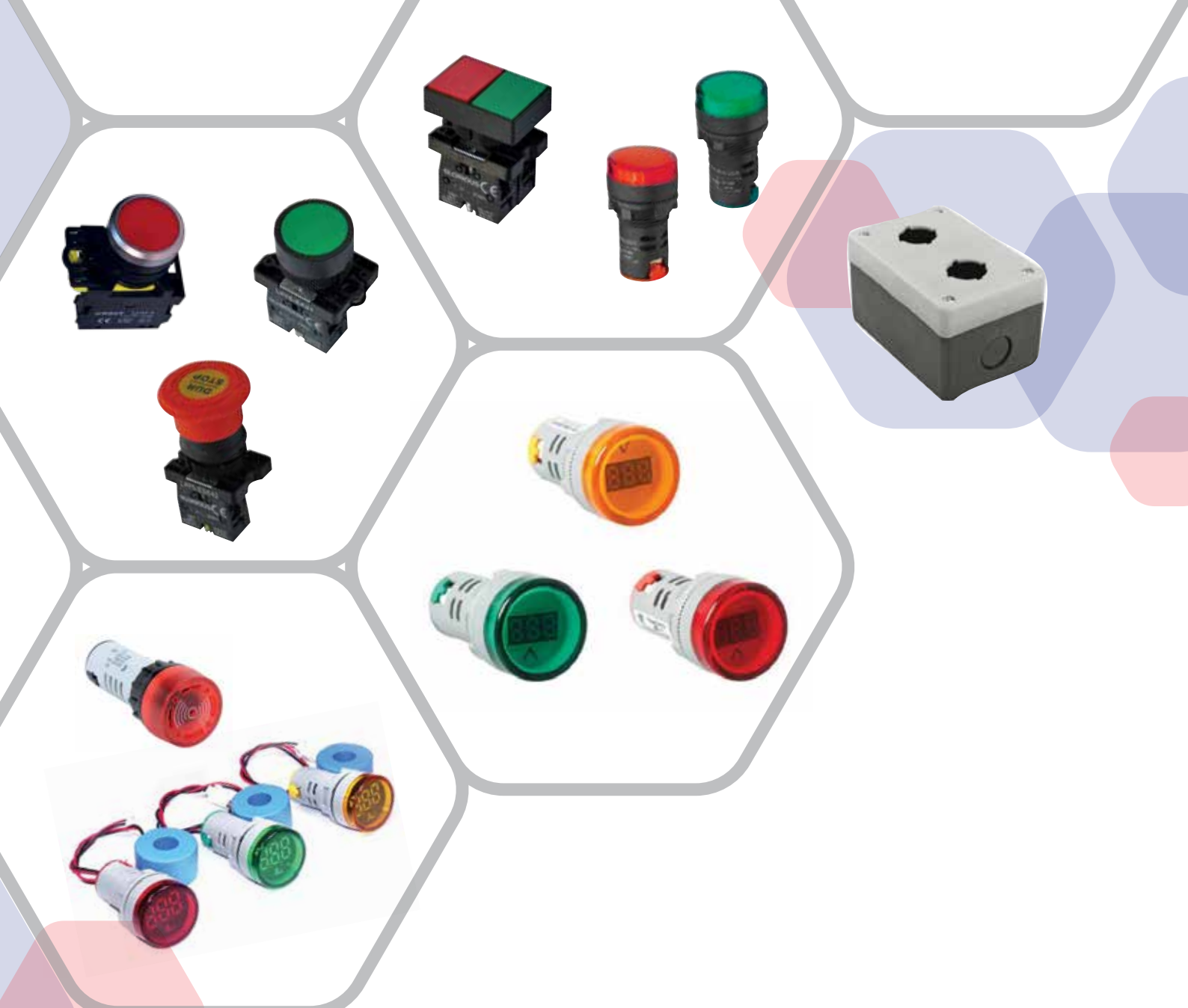

BUTON & AKSESUARLARI

SOLMAZSAN®

YAYLI BUTONLAR

ÜRÜN KODU	AÇIKLAMA	KONTAK	K. ADEDİ	₺ / ADET
SK EA310	Start Buton 22mm	NO	20	50,00
SK EA420	Stop Buton 22mm	NC	20	50,00
SK ED210	0-1 Kalıcı Mandal Buton 22 mm	NC	20	61,00
SK ED330	1-0-2 Kalıcı Mandal Buton 22 mm	NO+NO	20	100,00
SK EA845	İkiz Buton 22 mm	NO+NC	20	140,00
SK ES542	Acil Stop Butonu 22 mm	NC	20	87,50
SK ED410	0-1 Yaylı Mandal Buton 22 mm	NC	20	61,00
SK ED530	1-0-2 Yaylı Mandal Buton 22 mm	NO+NO	20	100,00
SK ZB101	Start Kontak	NO	20	27,50
SK ZB102	Stop Kontak	NC	20	27,50

ÜRÜN KODU	AÇIKLAMA	KONTAK	K. ADEDİ	₺ / ADET
SK A5-10	Start Buton 22mm	NO	10	85,00
SK A5-01	Stop Buton 22mm	NC	10	85,00
SK A5-10X	0-1 Kalıcı Mandal Buton 22 mm	NC	10	98,00
SK A5-20XS	1-0-2 Kalıcı Mandal Buton 22 mm	NO+NO	10	132,00
SK A5-11R	İkiz Buton 22 mm	NO+NC	10	162,00
SK A5-01ZS	Acil Stop Butonu 22 mm	NC	10	113,00
SK A5-10XFU	0-1 Yaylı Mandal Buton 22 mm	NC	10	105,00
SK A5-20XSFU	1-0-2 Yaylı Mandal Buton 22 mm	NO+NO	10	140,00
SK A-10	Start Kontak	NO	10	35,00
SK A-01	Stop Kontak	NC	10	35,00
BR1	Buton Rozeti 22 mm		10	5,00
ER60	Acil Stop (Emergency) Etiketi 22 mm		10	14,30

İŞIKLI YAYLI BUTONLAR

ÜRÜN KODU	AÇIKLAMA	KONTAK	K. ADEDİ	₺ / ADET
SK A5-10D	Start Buton 22 mm - Yeşil Işıklı	1NO	10	160,00
SK A5-01D	Stop Buton 22 mm - Kırmızı Işıklı	1NC	10	160,00
SK A5-10XD	0-1 Mandal Buton 22 mm - Yeşil Işıklı	1NO	10	160,00
SK A5-01XD	0-1 Mandal Buton 22 mm - Kırmızı Işıklı	1NC	10	160,00
SK A5-20XSD	1-0-2 Mandal Buton 22 mm - Yeşil Işıklı	2NO	10	195,00
SK A5-02XSD	1-0-2 Mandal Buton 22 mm - Kırmızı Işıklı	2NC	10	195,00
SK A5-11RD	Işıklı İkiz Buton 22 mm	1NO+1NC	10	220,00

22 mm BUZZER 90 dB

ÜRÜN KODU	AÇIKLAMA	K. ADEDİ	₺ / ADET
AD116-0085	Ledli Buzzer AC 220V Kırmızı	10	130,00
AD116-0084	Ledli Buzzer AC - DC 24V Kırmızı	10	130,00

22 mm POTANSİYOMETRE

ÜRÜN KODU	VOLTAJ	AÇIKLAMA	K. ADEDİ	₺ / ADET
APT22-5K	220V	5K Potansiyometre Tek Tur	10	190,00
APT22-10K	220V	10K Potansiyometre Tek Tur	10	190,00

22 mm LEDLİ SİNYAL LAMBASI



ÜRÜN KODU	RENK	VOLTAJ	AÇIKLAMA	K. ADEDİ	₺ / ADET
SK 22-220Y	●	220V AC	Led Işıklı Sinyal Lambası 22 mm	10	32,00
SK 22-220K	●	220V AC	Led Işıklı Sinyal Lambası 22 mm	10	32,00
SK 22-220S	●	220V AC	Led Işıklı Sinyal Lambası 22 mm	10	32,00
SK 22-220B	○	220V AC	Led Işıklı Sinyal Lambası 22 mm	10	38,00
SK 22-220M	●	220V AC	Led Işıklı Sinyal Lambası 22 mm	10	32,00
SK 22-24Y	●	24V AC-DC	Led Işıklı Sinyal Lambası 22 mm	10	32,00
SK 22-24K	●	24V AC-DC	Led Işıklı Sinyal Lambası 22 mm	10	32,00
SK 22-24S	●	24V AC-DC	Led Işıklı Sinyal Lambası 22 mm	10	32,00

16 mm LEDLİ SİNYAL LAMBASI



ÜRÜN KODU	RENK	VOLTAJ	AÇIKLAMA	K. ADEDİ	₺ / ADET
SK 16-220Y	●	220V AC	Led Işıklı Sinyal Lambası 16 mm	10	44,00
SK 16-220K	●	220V AC	Led Işıklı Sinyal Lambası 16 mm	10	44,00
SK 16-220S	●	220V AC	Led Işıklı Sinyal Lambası 16 mm	10	44,00
SK 16-220B	○	220V AC	Led Işıklı Sinyal Lambası 16 mm	10	60,00
SK 16-220M	●	220V AC	Led Işıklı Sinyal Lambası 16 mm	10	44,00
SK 16-24Y	●	24V AC-DC	Led Işıklı Sinyal Lambası 16 mm	10	44,00
SK 16-24K	●	24V AC-DC	Led Işıklı Sinyal Lambası 16 mm	10	44,00
SK 16-24S	●	24V AC-DC	Led Işıklı Sinyal Lambası 16 mm	10	44,00

10 mm PLASTİK KABLOLU SİNYAL LAMBASI



ÜRÜN KODU	RENK	VOLTAJ	AÇIKLAMA	K. ADEDİ	₺ / ADET
AD22E005R	●	220V	Kablolu Sinyal 10 mm	100	27,00
AD22E005G	●	220V	Kablolu Sinyal 10 mm	100	27,00
AD22E005Y	●	220V	Kablolu Sinyal 10 mm	100	27,00

22 mm VOLTMETRE & AMPERMETRE



ÜRÜN KODU	AÇIKLAMA	K. ADEDİ	₺ / ADET
SK 22-VS-K	22 mm Voltmetre 24-450V - Kırmızı	10	120,00
SK 22-VS-Y	22 mm Voltmetre 24-450V - Yeşil	10	120,00
SK 22-VS-S	22 mm Voltmetre 24-450V - Sarı	10	120,00
SK 22-AS-K	22 mm Ampermetre 100A - Kırmızı	10	240,00
SK 22-AS-Y	22 mm Ampermetre 100A - Yeşil	10	240,00
SK 22-AS-S	22 mm Ampermetre 100A - Sarı	10	240,00
SK 22-VAS-K	22 mm Amper+Volt - Kırmızı	10	430,00
SK 22-VAS-Y	22 mm Amper+Volt - Yeşil	10	430,00
SK 22-VAS-S	22 mm Amper+Volt - Sarı	10	430,00

BOŞ KUMANDA KUTULARI



ÜRÜN KODU	AÇIKLAMA	K. ADEDİ	₺ / ADET
SK-BH100	1'li Boş Kutu	1	58,00
SK-BH200	2'li Boş Kutu	1	72,00
SK-BH300	3'lü Boş Kutu	1	93,00
SK-BH400	4'lü Boş Kutu	1	117,00
SK-BH500	5'li Boş Kutu	1	175,00
SK-BH600	6'lı Boş Kutu	1	175,00
LAY2-KSE542	1'li Mantar Acil Stop Butonu	1	148,00



SİVİÇLER, VİNÇ KUMANDA BUTONLARI & PEDALLAR

SOLMAZSAN®

DOĞRUSAL HAREKETLİ METAL PİM



KOD	CLS101
KUTU ADEDİ	10
ADET / \$	7,43 \$

DOĞRUSAL HAREKETLİ METAL MAKARALI PİM



KOD	CLS103
KUTU ADEDİ	10
ADET / \$	7,43 \$

DOĞRUSAL HAREKETLİ METAL MAKARALI PİM + RESETLİ



KOD	CLS103R
KUTU ADEDİ	10
ADET / \$	7,99 \$

AÇISAL HAREKETLİ 14 mm METAL MAKARALI PİM



KOD	CLS111
KUTU ADEDİ	10
ADET / \$	7,43 \$

AÇISAL HAREKETLİ 18 mm MAKARALI DÖNER KOL



KOD	CLS121
KUTU ADEDİ	10
ADET / \$	7,43 \$

AÇISAL HAREKETLİ 18 mm AYARLANABİLİR MAKARALI DÖNER KOL

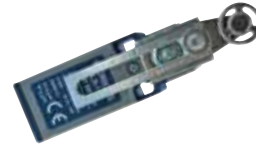

KOD	CLS131
KUTU ADEDİ	10
ADET / \$	7,99 \$

AÇISAL HAREKETLİ SİRAL TELLİ ÇOK YÖNLÜ KOL



KOD	CLS161
KUTU ADEDİ	10
ADET / \$	7,99 \$

AÇISAL HAREKETLİ 18 mm AYARLANABİLİR MAKARALI



KOD	CLS191
KUTU ADEDİ	10
ADET / \$	7,99 \$

BUTON TAHRİKLİ METAL



KOD	CSA001
KUTU ADEDİ	10
ADET / \$	30,50 \$

METAL MAKARA DİKEY



KOD	CSA003
KUTU ADEDİ	10
ADET / \$	30,50 \$

METAL MAKARA KOL YATAY



KOD	CSA012
KUTU ADEDİ	10
ADET / \$	30,50 \$

18mm SAĞ - SOL METAL MAKARA



KOD	CSA021
KUTU ADEDİ	10
ADET / \$	30,50 \$

18mm AYARLI SAĞ - SOL METAL MAKARA



KOD	CSA031
KUTU ADEDİ	10
ADET / \$	30,50 \$

SİRAL TELLİ METAL



KOD	CSA061
KUTU ADEDİ	10
ADET / \$	30,50 \$

AÇIK KONTAK PANO KAPI SWITCH



KOD	AKS10
KUTU ADEDİ	10
ADET / ₺	50,00

KAPALI KONTAK PANO KAPI SWITCH



KOD	AKS01
KUTU ADEDİ	10
ADET / ₺	55,00

MİKRO SİVİÇLER



6811

6812



6813

6814



6815

6817



6818

6819



6820

6821

6822

6823

6824

ÜRÜN KODU	AÇIKLAMA	K. ADEDİ	\$/ ADET
6811	İnce Kısa Pimli 15A 1NO + 1NC	20	3,99 \$
6812	Kalın Uzun Pimli 15A 1NO + 1NC	20	4,44 \$
6813	İnce Uzun Pimli 15A 1NO + 1NC	20	5,10 \$
6814	Uzun Palet 15A 1NO + 1NC	20	4,44 \$
6815	Uzun Palet Metal Makaralı 15A 1NO + 1NC	20	4,77 \$
6817	Kısa Paletli 15A 1NO + 1NC	20	4,44 \$
6818	Kısa Metal Makaralı 15A 1NO + 1NC	20	4,77 \$
6819	Tahrikli Metal Makaralı 15A 1NO + 1NC	20	5,35 \$
6820	Dikey Metal Makaralı 15A 1NO + 1NC	20	6,66 \$
6821	Kalın Kısa Metal Pimli 15A 1NO + 1NC	20	5,77 \$
6822	Yan Dik Metal Makaralı 15A 1NO + 1NC	20	6,66 \$
6823	Uzun Tel Palet 15A 1NO + 1NC	20	4,77 \$
6824	Koruma Kabı	20	0,78 \$

VİNÇ KUMANDA BUTONLARI



ÜRÜN KODU	AÇIKLAMA	K. ADEDİ	\$/ ADET
COB-61	2'li Tek hızlı vinç kumanda butonu	1	5,80 \$
COB-62	4'lü Tek hızlı vinç kumanda butonu	1	7,50 \$
COB-63	6'lı Tek hızlı vinç kumanda butonu	1	10,00 \$
COB-64	8'li Tek hızlı vinç kumanda butonu	1	13,00 \$

ACİL STOPLU VİNÇ KUMANDA BUTONLARI



ÜRÜN KODU	AÇIKLAMA	K. ADEDİ	\$/ ADET
COB-C1	2'li Tek hızlı + acil stoplu vinç kumanda butonu	1	23,00 \$
COB-C2	4'lü Tek hızlı + acil stoplu vinç kumanda butonu	1	32,00 \$
COB-C3	6'lı Tek hızlı + acil stoplu vinç kumanda butonu	1	41,00 \$

AYAK PEDALLARI

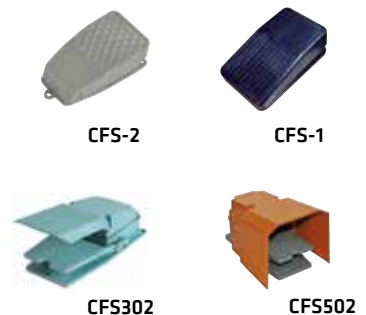

CFS-2

CFS-1

CFS302

CFS502

ÜRÜN KODU	AÇIKLAMA	K. ADEDİ	\$/ ADET
CFS1	Metal ayak pedali	1	8,50 \$
CFS-2	Metal ayak pedali	1	12,00 \$
CFS502	Metal ayak pedali	1	48,00 \$



MESNET İZOLATÖRLERİ

SOLMAZSAN®

M5 MİNİ İZOLATÖR 25MM



ÜRÜN KODU	AÇIKLAMA	KOLİ AD.	KUTU AD.	₺ / ADET
BMI-M5/2C	Saplamalı İzolatör	1500	100	20,00
BMI-M5/1C+1S	Saplama + Kör Somun İzolatör	1500	100	23,00

M6 ORTA BOY KONİK İZOLATÖR

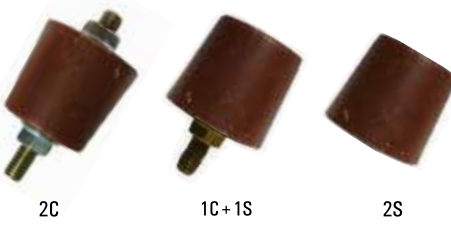

ÜRÜN KODU	AÇIKLAMA	KOLİ AD.	KUTU AD.	₺ / ADET
BMI-M6/2C	Saplamalı İzolatör	500	100	25,50
BMI-M6/1C+1S	Saplama + Kör Somun İzolatör	500	100	28,50
BMI-M6/2S	Kör Somun İzolatör	500	80	33,00

M8 BÜYÜK BOY FIÇI İZOLATÖR 40mm



ÜRÜN KODU	AÇIKLAMA	KOLİ AD.	KUTU AD.	₺ / ADET
BMI-M8/2C	Saplamalı İzolatör	250	50	44,00
BMI-M8/1C+1S	Saplama + Kör Somun İzolatör	250	50	48,00
BMI-M8/2S	Kör Somun İzolatör	250	50	50,00

M10 BÜYÜK BOY FIÇI İZOLATÖR 40mm



ÜRÜN KODU	AÇIKLAMA	KOLİ AD.	KUTU AD.	₺ / ADET
BMI-M10/2C	Saplamalı İzolatör	200	40	61,00
BMI-M10/1C+1S	Saplama + Kör Somun İzolatör	200	40	64,50
BMI-M10/2S	Kör Somun İzolatör	200	40	68,00

BARA TUTUCU SERFİL (SAC KALINLIĞI 5 mm)



ÜRÜN KODU	AÇIKLAMA	KOLİ AD.	KUTU AD.	₺ / ADET
SERFİL M8	BMI-M 8- M 10	300	50	46,00

1N-500 İZOLATÖRLER



ÜRÜN KODU	AÇIKLAMA	KUTU AD.	₺ / ADET
1NK-500M8	1NK-500 İzolatör M8	80	97,00
1NK-500M10	1NK-500 İzolatör M10	80	113,00
1NK-500M12	1NK-500 İzolatör M12	80	122,00

1N-1000 İZOLATÖRLER



ÜRÜN KODU	AÇIKLAMA	KUTU AD.	₺ / ADET
1NK-1000M12	1NK-1000 İzolatör M12	36	
1NK-1000M16	1NK-1000 İzolatör M16	36	

Fiyat Sorunuz



ÜRÜN KODU	AÇIKLAMA	KUTU AD.	₺ / ADET
3x1F	3x1F Tarak İzolatör	60	62,00



ÜRÜN KODU	AÇIKLAMA	KUTU AD.	₺ / ADET
3x2F	3x2F Tarak İzolatör	48	82,50



ÜRÜN KODU	AÇIKLAMA	KUTU AD.	₺ / ADET
3x1F+N	3x1F+N(4x1F) Tarak İzolatör	30	86,50



ÜRÜN KODU	AÇIKLAMA	KUTU AD.	₺ / ADET
3x2F+N	3x2F+N Tarak İzolatör	30	115,00

MESNET İZOLATÖRÜ (PLASTİK)



Fiyat Sorunuz



PANO AKSESUARLARI & BANTLAR

SOLMAZSAN®

ISIYLA DARALAN MAKARON



ÜRÜN KODU	Ölçüler		Daralmadan Önce (mm)		Daralmadan Sonra (mm)		Makara (m)	Metre Fiyatı (\$)
	İnch	mm	İç Çap	Cidar Kalınlığı	İç Çap	Cidar Kalınlığı		
IDM 1	-	1	2,0 ± 0,3	0,16 ± 0,05	0,70	0,30 ± 0,05	200	0,094 \$
IDM 1,5	-	1,5	2,0 ± 0,3	0,16 ± 0,05	0,80	0,30 ± 0,05	200	0,107 \$
IDM 2	-	2	2,5 ± 0,3	0,16 ± 0,05	1,00	0,35 ± 0,05	200	0,127 \$
IDM 2,4	3/32	2,4	3,0 ± 0,3	0,16 ± 0,05	1,50	0,35 ± 0,05	200	0,127 \$
IDM 2,5	-	2,5	3,0 ± 0,3	0,16 ± 0,05	1,25	0,38 ± 0,05	200	0,166 \$
IDM 3	-	3	3,5 ± 0,4	0,20 ± 0,05	1,50	0,38 ± 0,05	200	0,177 \$
IDM 3,2	1/8	3,2	3,5 ± 0,4	0,20 ± 0,05	1,75	0,40 ± 0,05	200	0,177 \$
IDM 3,5	-	3,5	4,0 ± 0,4	0,20 ± 0,05	1,75	0,40 ± 0,05	200	0,188 \$
IDM 4	-	4	4,5 ± 0,4	0,20 ± 0,05	2,00	0,45 ± 0,05	200	0,222 \$
IDM 4,5	-	4,5	4,8 ± 0,4	0,20 ± 0,05	2,00	0,47 ± 0,08	200	0,255 \$
IDM 4,8	3/16	4,8	5,2 ± 0,4	0,20 ± 0,05	2,60	0,47 ± 0,08	200	0,255 \$
IDM 5	-	5	5,5 ± 0,4	0,20 ± 0,05	2,50	0,55 ± 0,08	200	0,277 \$
IDM 6	-	6	6,5 ± 0,4	0,22 ± 0,05	3,00	0,55 ± 0,08	200	0,321 \$
IDM 6,4	1/4	6,4	7,0 ± 0,4	0,28 ± 0,05	3,50	0,55 ± 0,08	200	0,321 \$
IDM 7	-	7	7,5 ± 0,4	0,28 ± 0,05	3,50	0,60 ± 0,08	100	0,388 \$
IDM 8	-	8	8,5 ± 0,4	0,30 ± 0,08	4,00	0,60 ± 0,08	100	0,388 \$
IDM 9,5	3/8	9,5	10,0 ± 0,5	0,30 ± 0,08	5,00	0,60 ± 0,08	100	0,389 \$
IDM 10	-	10	10,0 ± 0,5	0,30 ± 0,08	5,00	0,60 ± 0,08	100	0,432 \$
IDM 12,7	1/2	12,7	13,0 ± 0,5	0,33 ± 0,10	6,50	0,65 ± 0,08	100	0,499 \$
IDM 13	-	13	13,5 ± 0,5	0,33 ± 0,10	6,50	0,65 ± 0,08	100	0,532 \$
IDM 14	-	14	14,0 ± 0,5	0,33 ± 0,10	7,00	0,70 ± 0,08	100	0,621 \$
IDM 16	-	16	16,5 ± 0,6	0,35 ± 0,12	8,00	0,75 ± 0,08	100	0,830 \$
IDM 18	-	18	19,0 ± 0,6	0,40 ± 0,15	9,00	0,80 ± 0,15	100	1,080 \$
IDM 19,1	3/4	19,1	20,5 ± 0,6	0,40 ± 0,15	10,00	0,80 ± 0,15	100	1,080 \$
IDM 20	4/5	20	20,5 ± 0,6	0,40 ± 0,15	10,00	0,80 ± 0,15	100	1,380 \$
IDM 22	-	22	22,5 ± 0,7	0,45 ± 0,15	12,00	0,95 ± 0,15	100	1,720 \$
IDM 25,4	1	25,4	25,6 ± 0,7	0,45 ± 0,15	12,00	0,95 ± 0,15	50	1,830 \$
IDM 30	-	30	31,5 ± 0,7	0,50 ± 0,15	15,00	0,95 ± 0,15	50	2,380 \$
IDM 32	1-1/4	32	33,0 ± 0,7	0,50 ± 0,15	16,50	0,95 ± 0,15	50	2,380 \$
IDM 35	-	35	38,0 ± 0,7	0,50 ± 0,15	16,00	1,00 ± 0,15	50	2,990 \$
IDM 38	1-1/2	38	40,0 ± 0,7	0,50 ± 0,15	20,00	1,00 ± 0,15	50	3,330 \$
IDM 40	-	40	40,5 ± 0,7	0,50 ± 0,15	20,00	1,00 ± 0,15	50	3,330 \$
IDM 51	2	51	52,5 ± 0,7	0,50 ± 0,15	25,00	1,00 ± 0,15	25	4,210 \$
IDM 60	-	60	60,5 ± 0,8	0,52 ± 0,15	30,00	1,00 ± 0,16	25	5,660 \$
IDM 70	-	70	70,5 ± 1,0	0,55 ± 0,15	40,00	1,10 ± 0,18	25	7,540 \$
IDM 80	-	80	82,0 ± 1,0	0,55 ± 0,15	40,00	1,10 ± 0,18	25	8,320 \$
IDM 102	4	102	105,0 ± 1,0	0,55 ± 0,15	51,00	1,10 ± 0,18	25	10,540 \$
IDM 120	5	120	120,0 ± 1,0	0,55 ± 0,15	60,00	1,10 ± 0,18	25	14,430 \$
IDM 150	-	150	150,0 ± 1,0	0,55 ± 0,15	76,00	1,10 ± 0,18	25	21,000 \$
IDM 180	-	180	180,0 ± 1,0	0,55 ± 0,15	90,00	1,10 ± 0,18	25	29,970 \$

TEKNİK ÖZELLİKLER

Malzeme : Polyolefin
 Daralma Oranı : 2/1
 Yanmazlık : Kendi kendine söner
 Çalışma Sıcaklığı : -55°C -- +125°C



*Renkli makaronlar için fiyat sorunuz.

İÇİ YAPIŞKANLI DARALAN MAKARONLAR



TEKNİK ÖZELLİKLER

Malzeme : Polyolefin
Daralma Oranı : 3/1
Yanmazlık : Kendi kendine söner
Çalışma Sıcaklığı : -55°C -- +125°C

ÜRÜN KODU	Ölçü (mm)	Daralmadan Önce (mm)	Daralmadan Sonra (mm)			Makara (m)	Birim Fiyatı (\$) / Metre
		İç Çap	Çap	Cidar Kalınlığı	Yapışkan Katmanı		
4418	3/1	3	1,00	1,10 ± 0,10	0,50	200	0,720 \$
4419	4,8/1,5	4,8	1,50	1,20 ± 0,10	0,50	100	0,888 \$
4420	6/2	6	2,00	1,30 ± 0,10	0,50	100	1,332 \$
4421	9/3	9	3,00	1,70 ± 0,15	0,60	50	1,776 \$
4405	12/4	12	4,00	2,00 ± 0,20	0,80	1,20 Boy	2,553 \$
4406	16/5	16	5,00	2,20 ± 0,20	0,80	1,20 Boy	3,552 \$
4407	19/6	19	6,00	2,20 ± 0,20	0,80	1,20 Boy	4,995 \$
4408	28/9	28	9,00	2,40 ± 0,20	1,05	1,20 Boy	5,661 \$
4409	33/10	33	10,00	2,50 ± 0,20	1,05	1,20 Boy	6,438 \$
4410	40/12	40	12,00	2,50 ± 0,20	1,05	1,20 Boy	7,104 \$
4411	44/14	44	14,00	2,50 ± 0,20	1,05	1,20 Boy	7,881 \$
4412	52/18	52	18,00	2,50 ± 0,20	1,05	1,20 Boy	8,880 \$
4414	70/25	70	25,00	3,00 ± 0,30	1,35	1,20 Boy	12,540 \$
4415	90/30	90	30,00	3,00 ± 0,30	1,35	1,20 Boy	17,760 \$
4416	125/40	125	40,00	3,00 ± 0,30	1,35	1,20 Boy	22,220 \$

H CLASS CAM ELYAF SİLİKON İZOLELİ MAKARONLAR



ÜRÜN KODU	ÇAP (mm)	METRE	\$ / ADET
IDM 2H	2	200	0,277 \$
IDM 3H	3	100	0,421 \$
IDM 4H	4	100	0,577 \$
IDM 5H	5	100	0,688 \$
IDM 6H	6	100	0,854 \$
IDM 7H	7	100	0,976 \$
IDM 8H	8	50	1,110 \$
IDM 10H	10	50	1,520 \$
IDM 12H	12	50	1,880 \$
IDM 14H	14	50	2,270 \$
IDM 16H	16	25	2,990 \$
IDM 18H	18	25	3,880 \$
IDM 20H	20	25	4,990 \$
IDM 25H	25	25	9,430 \$
IDM 30H	30	25	13,870 \$
IDM 35H	35	25	16,650 \$

KABLO ÇORABI (HALOGEN FREE)



ÜRÜN KODU	AÇIKLAMA	KOLİ ADEDİ	\$/ ADET
KTC 5	Kablo toplama çorabı	100	0,320 \$
KTC 8	Kablo toplama çorabı	100	0,333 \$
KTC 10	Kablo toplama çorabı	100	0,399 \$
KTC 12	Kablo toplama çorabı	100	0,477 \$
KTC 15	Kablo toplama çorabı	100	0,532 \$
KTC 20	Kablo toplama çorabı	100	0,621 \$
KTC 25	Kablo toplama çorabı	100	0,799 \$
KTC 30	Kablo toplama çorabı	50	0,965 \$
KTC 40	Kablo toplama çorabı	50	1,265 \$
KTC 50	Kablo toplama çorabı	25	1,554 \$

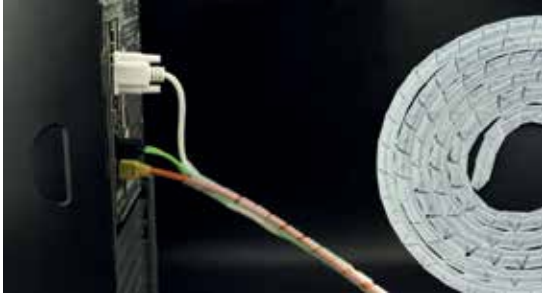

HELEZON SİRALLER RULO

ÜRÜN KODU		Rulo	Paket (mt)	\$/ ADET
3251	No.1	1	10	6,00
3252	No.2	1	10	8,00
3253	No.3	1	10	9,60
3254	No.4	1	10	12,40
3255	No.5	1	10	20,00



BANTLAR

ÜRÜN KODU	AÇIKLAMALAR	KOLİ ADEDİ	\$/ ADET
SK 4801	Eriyen bant (19 mm)	60	
SK 4802	Eriyen bant (50 mm)	24	
SK 4809	İzole bant	500	
SK 4810	Geniş izole bant	36	

Fiyat Sorunuz



PANO İÇİ TERMOSTAT

ÜRÜN KODU	AÇIKLAMALAR	K. ADEDİ	\$/ ADET
ÇTR02K	Isıtma termostatu	1	230,00
ÇTR01M	Soğutma termostatu	1	230,00



RAYA GEÇMELİ PANO PRİZİ

ÜRÜN KODU	AÇIKLAMALAR	K. ADEDİ	\$/ ADET
CP 6801	Raya geçmeli pano prizi - kapaklı	10	

Fiyat Sorunuz

KARE FANLAR



ÜRÜN KODU	ÜRÜN ÖLÇÜLERİ (cm)		KOLİ ADEDİ	\$/ ADET
BRZ 01	120 x 120 x 25	220V AC	1	14,50 \$
BRZ 02	120 x 120 x 38	220V AC	1	14,50 \$
BRZ 04	120 x 120 x 25	12V DC	1	11,00 \$
BRZ 05	120 x 120 x 25	24V DC	1	11,00 \$
BRZ 08	120 x 120 x 38	110V AC	1	13,00 \$
BRZ 14	80 x 80 x 38	220V AC	1	13,00 \$
BRZ 16	80 x 80 x 25	12V DC	1	6,50 \$
BRZ 17	80 x 80 x 25	24V DC	1	6,50 \$
BRZ 21	172 x 150 x 51	220V AC	1	43,00 \$
BRZ 22	172 x 150 x 51	24V DC	1	43,00 \$
BRZ 23	172 x 150 x 51	115V AC	1	43,00 \$

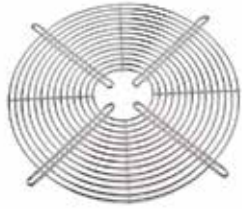

KARE FAN KORUMA TELİ

ÜRÜN KODU	ÜRÜN ÖLÇÜLERİ (cm)		KOLİ ADEDİ	\$/ ADET
TEL 01	80 x 80	fan teli	1	1,20 \$
TEL 03	120 x 120	fan teli	1	1,90 \$
TEL 04	170 x 150	fan teli	1	2,40 \$

SOMUNLU POLYAMİD KABLO RAKORU



ÜRÜN KODU	MONTAJ ÇAPI (mm)	SIKMA ÇAPI (mm)	K. ADEDİ	\$/ ADET
PG 7	13	3-6,5	500	
PG 9	16	4-8	300	
PG 11	19	5-10	200	
PG 13,5	21	6-12	150	
PG 16	23	10-14	125	
PG 21	29	13-18	75	Fiyat Sorunuz
PG 29	37,5	18-25	40	
PG 36	47,5	22-32	20	
PG 42	54,5	30-38	10	
PG 48	60	34-44	8	

PİRİNÇ KABLO RAKORU (NİKEL KAPLAMA SOMUNLU) IP68)



ÜRÜN KODU	MONTAJ ÇAPI (mm)	SIKMA ÇAPI (mm)	K. ADEDİ	\$/ ADET
PG 7/P	13	3-6,5	50	
PG 9/P	16	4-8	50	
PG 11/P	19	5-10	50	
PG 13,5/P	21	6-12	50	
PG 16/P	23	10-14	25	
PG 21/P	29	13-18	25	Fiyat Sorunuz
PG 29/P	37,5	18-25	20	
PG 36/P	47,5	22-32	15	
PG 42/P	54,5	30-38	12	
PG 48/P	60	34-44	12	

KAUÇUK FİŞ - PRİZ & AKSESUARLARI & EL ALETLERİ

SOLMAZSAN®



1 x 16 KAUÇUK MONOFAZE ERKEK FİŞ



KOD	SK 2101
KUTU ADEDİ	50
KOLİ ADEDİ	300
ADET / ₺	36,75

1 x 16 KAUÇUK L FİŞ



KOD	SK 2109
KUTU ADEDİ	40
KOLİ ADEDİ	480
ADET / ₺	37,00

1 x 16 KAUÇUK MONOFAZE DIŞI FİŞ



KOD	SK 2103
KUTU ADEDİ	30
KOLİ ADEDİ	240
ADET / ₺	40,50

1 x 16 MONOFAZE TOPRAKLI DUVAR PRİZ



KOD	SK 2104
KUTU ADEDİ	18
KOLİ ADEDİ	108
ADET / ₺	82,50

1 x 16 KAUÇUK MONOFAZE 2'Lİ GRUP PRİZ



KOD	SK 2105
KUTU ADEDİ	8
KOLİ ADEDİ	96
ADET / ₺	112,50

1 x 16 KAUÇUK MONOFAZE 3'LÜ GRUP PRİZ



KOD	SK 2106
KUTU ADEDİ	6
KOLİ ADEDİ	72
ADET / ₺	123,75

1 x 16 KAUÇUK MONOFAZE 4'LÜ GRUP PRİZ



KOD	SK 2107
KUTU ADEDİ	5
KOLİ ADEDİ	50
ADET / ₺	147,00

3 x 25 KAUÇUK TRİFAZE ERKEK FİŞ



KOD	SK 2201
KUTU ADEDİ	30
KOLİ ADEDİ	180
ADET / ₺	94,50

3 x 25 KAUÇUK TRİFAZE DIŞI FİŞ



KOD	SK 2204
KUTU ADEDİ	20
KOLİ ADEDİ	120
ADET / ₺	112,50

3 x 25 KAUÇUK TRİFAZE DUVAR PRİZ



KOD	SK 2205
KUTU ADEDİ	18
KOLİ ADEDİ	108
ADET / ₺	160,50

3 x 25 3'LÜ TRİFAZE GRUP PRİZ



KOD	SK 2213
KUTU ADEDİ	6
KOLİ ADEDİ	36
ADET / ₺	381,00

1 MONOFAZE + 2 TRİFAZE 3'LÜ KAUÇUK PRİZ



KOD	SK 2212
KUTU ADEDİ	6
KOLİ ADEDİ	36
ADET / ₺	378,00

2 MONOFAZE + 1 TRİFAZE 3'LÜ KAUÇUK PRİZ



KOD	SK 2211
KUTU ADEDİ	6
KOLİ ADEDİ	36
ADET / ₺	375,00

TOPRAKLI ERKEK FİŞ

KOD	SK 1201
KUTU ADEDİ	50
KOLİ ADEDİ	600
ADET / ₺	33,75

TOPRAKLI DİŞİ FİŞ

KOD	SK 1202
KUTU ADEDİ	50
KOLİ ADEDİ	600
ADET / ₺	36,00

MİMOZA ERKEK FİŞ

KOD	SK 1203
KUTU ADEDİ	50
KOLİ ADEDİ	950
ADET / ₺	25,50

MİMOZA DİŞİ FİŞ

KOD	SK 1204
KUTU ADEDİ	50
KOLİ ADEDİ	100
ADET / ₺	25,50

TOPRAKLI L FİŞ

KOD	SK 1205
KUTU ADEDİ	50
KOLİ ADEDİ	1000
ADET / ₺	34,50

ARAPUAR

KOD	1207
KUTU ADEDİ	50
KOLİ ADEDİ	1000
ADET / ₺	25,50

ANAHTARLI ERKEK FİŞ (IŞIKLI)

KOD	SK 2307
KUTU ADEDİ	50
KOLİ ADEDİ	300
ADET / ₺	87,00

DUY FİŞ

KOD	SK 1209
KUTU ADEDİ	50
KOLİ ADEDİ	500
ADET / ₺	25,50

İNGİLİZ ADAPTÖRÜ

KOD	SK 1212
KUTU ADEDİ	50
KOLİ ADEDİ	600
ADET / ₺	37,00

YAĞMUR DUY

KOD	SK 2305
KUTU ADEDİ	50
KOLİ ADEDİ	300
ADET / ₺	25,50

TİJ TAKIMI

KOD	SK 2304
KUTU ADEDİ	50
KOLİ ADEDİ	300
ADET / ₺	28,00

0,25 - 6 mm² YÜKSÜK SIKMA PENSESİ (GW-B4)



KOD	5026
KUTU ADEDİ	1

73.00 USD

0.08 - 6 mm² YÜKSÜK SIKMA PENSESİ (4 Köşe) (GW-8)



KOD	5008
KUTU ADEDİ	1

99.90 USD

0.50 - 6 mm² İZOLELİ KABLO UCU SIKMA PENSESİ (GW-1)



KOD	5016
KUTU ADEDİ	1

65.50 USD

6 - 50 mm² SKP SIKMA PENSESİ (JY - 0650)



KOD	5045
KUTU ADEDİ	1

95.00 USD

10 - 120 mm² HİDROLİK SKP SIKMA PENSESİ (YOQ 120)



(Çantalı Set)

KOD	5050
KUTU ADEDİ	1

150.00 USD

60 mm² KABLO KESME MAKASI (CC-60)



KOD	5040
KUTU ADEDİ	1

47.70 USD

250 mm² KABLO KESME MAKASI (TC-250)



KOD	5042
KUTU ADEDİ	1

149.50 USD

6 - 16 mm² YÜKSÜK SIKMA PENSESİ (GW - 6)



KOD	5006
KUTU ADEDİ	1

76.50 USD

25 - 35 mm² YÜKSÜK SIKMA PENSESİ (GW - 17)



KOD	5015
KUTU ADEDİ	1

81.00 USD

0.50 - 6 mm² KABLO SIYIRMA PENSESİ (GW - 318)



KOD	5028
KUTU ADEDİ	1

36.50 USD

10 - 120 mm² SKP SIKMA PENSESİ (JY - 06120)



KOD	5046
KUTU ADEDİ	1

190.00 USD

16 - 300 mm² HİDROLİK SKP SIKMA PENSESİ (YQK 300)



(Çantalı Set)

KOD	5051
KUTU ADEDİ	1

160.00 USD

120 mm² KABLO KESME MAKASI (TC-100)



KOD	5041
KUTU ADEDİ	1

79.90 USD

630 mm² KABLO KESME MAKASI (TC-500)



KOD	5044
KUTU ADEDİ	1

216.50 USD



**ÖLÜM
TEHLİKESİ**



HAVAİ HAT BAĞLANTI KLEMENSLERİ & O.G. SİGORTALAR

SOLMAZSAN®

AL-CU KLEMENSLER



ÜRÜN KODU	SIKMA SAHASI (mm)	İLETKEN	KUTU ADEDİ	₺ / ADET
A25B16 TSE	6-25Al/2,5-16Cu	Rose	100	Fiyat Sorunuz
A40B25 TSE	16-40Al/10-25Cu	Rose, Lily, Swallow, Sparrow	100	
A70B50 TSE	16-70Al/10-50Cu	Rose, Lily, Swallow, Sparrow	50	
A120B70 TSE	7-120Al/10/70Cu	Pansy, Aster, Phlox, Oxlip, Raven, Pigeon	50	
A240B120 TSE	7-240Al/50-120Cu	Daisy, Peony, Tulip, Canna, Partridge, Ostrich, Hawk	25	
A240B240 TSE	240Al/240Cu	Daisy, Peony, Tulip, Canna, Partridge, Ostrich, Hawk	25	

ALÜMİNYUM PARALEL KLEMENSLER (Branşman-Atlama)



ÜRÜN KODU	SIKMA SAHASI (mm)	İLETKEN	KUTU ADEDİ	₺ / ADET
A16A16 TSE	6-16	Rose	100	Fiyat Sorunuz
A25A25 TSE	16-25	Rose	50	
A40A40 TSE	16-40	Rose, Lily, Swallow, Sparrow	25	
A70A70 TSE	16-70	Rose, Lily, Pansy, Swallow, Sparrow	50	
A120A120 TSE	40-120	Pansy, Aster, Phlox, Oxlip, Raven	50	
A240A240 TSE	70-240	Daisy, Peony, Tulip, Canna, Partridge, Ostrich, Hawk	50	

DURDURUCU KLEMENSLER



ÜRÜN KODU	SIKMA SAHASI (mm)	İLETKEN	KUTU ADEDİ	₺ / ADET
A16A50 TSE	16-50	Rose, Lily, Swallow, Sparrow	100	Fiyat Sorunuz
A50A95 TSE	50-95	Rose, Lily, Swallow, Sparrow	50	

İZOLELİ HAVAI HAT KLEMENSİ



ÜRÜN KODU	İLETKEN	KUTU ADEDİ	₺ / ADET
92950	Al 95-35mm, Cu 2,5-50mm	40	Fiyat Sorunuz
92951	Al 150-50mm, Cu 16-95mm	40	
92954	2'li İzoleli Klemens, Al 150-50mm, Cu 16-95mm	40	

DİREK İÇİ KLEMENS



ÜRÜN KODU	İLETKEN	KUTU ADEDİ	₺ / ADET
92896	Aydınlatma Direk İçi Klemens 1x(1,5-6) 2x(16-35mm)	200	Fiyat Sorunuz

KABLO BAĞLANTI ÜNİTELERİ



ÜRÜN KODU	İLETKEN	KUTU ADEDİ	₺ / ADET
96951	3 Adet 4x16mm' ye Kadar Kablo Bağlanabilir.	56	Fiyat Sorunuz



ASKI GERGİ APARATI

ÜRÜN KODU	İLETKEN	KUTU ADEDİ	₺ / ADET
92790	PA20000 Askı Gergi Aparatı Max.70mm	10	Fiyat Sorunuz



YÜKSEK GERİLİM FAZ GÖSTERGESİ

ÜRÜN KODU	İLETKEN	KUTU ADEDİ	₺ / ADET
78100	CVI Kontaklı IEC	10	Fiyat Sorunuz
78101	CVI Röleli Kontaklı IEC	10	Fiyat Sorunuz



O.G. SİGORTA

ÜRÜN KODU	AÇIKLAMA	KUTU ADEDİ	₺ / ADET
OGSA61	61 cm O.G. Sigorta (6.....50A) 36kV	12	Fiyat Sorunuz
OGSA51	51 cm O.G. Sigorta (6.....50A) 24kV	12	Fiyat Sorunuz



TEHLİKE LEVHALARI VE İKAZ ŞERİDİ

ÜRÜN KODU	AÇIKLAMALAR	KOLİ ADEDİ	₺ / ADET
ALM	Tehlike levhası	200	Fiyat Sorunuz
PLS.022	İkaz Şeridi	Kg.	Fiyat Sorunuz



KONTROL KALEMİ

ÜRÜN KODU	AÇIKLAMALAR	KOLİ ADEDİ	₺ / ADET
SK 158 EKO	Kontrol Kalem	50	Fiyat Sorunuz

MAKARA İZOLATÖRÜ ve AKSESUARLARI

ÜRÜN KODU	AÇIKLAMA	KUTU ADEDİ	₺ / ADET
BEM0001	Makara İzolatörü	60	Fiyat Sorunuz
BEM0002	İM 22 Mil	60	Fiyat Sorunuz
BEM0003	ÖD 85 Özengi Demiri	60	Fiyat Sorunuz
BEM0004	AK 100 Askı Kancası	60	Fiyat Sorunuz
BEM0008	E-80 İzolatör	90	Fiyat Sorunuz
BEM0009	E-80 İzolatör Demiri	90	Fiyat Sorunuz
BEM0010	D-80 Deve Boynu İzolatör Demiri	90	Fiyat Sorunuz
BEM0011	Makara İzolatör Takım	60	Fiyat Sorunuz



TAKIM



BEM0001



BEM0003



BEM0002



BEM0004



BEM0010



BEM0009



BEM0008



OTOMATİK BASINÇ KONTROL SİSTEMLERİ & FLATÖRLER

SOLMAZSAN®

MONOFAZE BASINÇ ŞALTERİ



ÜRÜN KODU	AÇIKLAMALAR	KOLİ ADEDİ	₺ / ADET
ELT-5	1 - 6 bar tahliyesiz, (1/4" - 1/2")	1	Fiyat Sorunuz
ELT-5C	1 - 6 bar tahliyeli, (1/4" - 1/2")	1	
ELT-5CO	1 - 6 bar tahliyeli ON/OFF, (1/4" - 1/2")	1	
ELT-5C-3Y	1 - 6 bar tahliyeli, 3 yollu, (1/4" - 1/2")	1	
ELT-5CO-3Y	1 - 6 bar tahliyeli, 3 yollu, ON-OFF, (1/4" - 1/2")	1	
ELT-6	2 - 11 bar tahliyesiz, (1/4" - 1/2")	1	
ELT-6C	2 - 11 bar tahliyeli, (1/4" - 1/2")	1	
ELT-6CO	2 - 11 bar tahliyeli, ON/OFF, (1/4" - 1/2")	1	
ELT-6C-3Y	2 - 11 bar tahliyeli, 3 yollu, (1/4" - 1/2")	1	
ELT-6CO-3Y	2 - 11 bar tahliyeli 3 yollu, ON-OFF, (1/4" - 1/2")	1	

Siparişte alt bağlantı 1/4 veya 1/2 olarak belirtiniz.

TRİFAZE BASINÇ ŞALTERİ



ÜRÜN KODU	AÇIKLAMALAR	KOLİ ADEDİ	₺ / ADET
ELT-2	2 - 8 bar tahliyesiz, (1/4" - 1/2")	1	Fiyat Sorunuz
ELT-2C	2 - 8 bar tahliyeli, (1/4" - 1/2")	1	
ELT-2CO	2 - 8 bar tahliyeli ON/OFF, (1/4" - 1/2")	1	
ELT-2C-3Y	2 - 8 bar tahliyeli, 3 yollu, (1/4" - 1/2")	1	
ELT-2CO-3Y	2 - 8 bar tahliyeli, 3 yollu, ON-OFF, (1/4" - 1/2")	1	
ELT-3	3 - 11 bar tahliyesiz, (1/4" - 1/2")	1	
ELT-3C	3 - 11 bar tahliyeli, (1/4" - 1/2")	1	
ELT-3CO	3 - 11 bar tahliyeli, ON/OFF, (1/4" - 1/2")	1	
ELT-3C-3Y	3 - 11 bar tahliyeli, 3 yollu, (1/4" - 1/2")	1	
ELT-3CO-3Y	3 - 11 bar tahliyeli 3 yollu, ON-OFF, (1/4" - 1/2")	1	
ELT-4	4 - 16 bar tahliyesiz, (1/4" - 1/2")	1	
ELT-4C	4 - 16 bar tahliyeli, (1/4" - 1/2")	1	
ELT-4CO	4 - 16 bar tahliyeli, ON/OFF, (1/4" - 1/2")	1	
ELT-4C-3Y	4 - 16 bar tahliyeli, 3 yollu, (1/4" - 1/2")	1	
ELT-4CO-3Y	4 - 16 bar tahliyeli, 3 yollu, ON/OFF (1/4" - 1/2")	1	

Siparişte alt bağlantı 1/4 veya 1/2 olarak belirtiniz.

PRESOSTATLAR



ÜRÜN KODU	AÇIKLAMALAR	KOLİ ADEDİ	₺ / ADET
ELT-35	0,2 - 8 bar (1/4" - 7/16")	1	Fiyat Sorunuz
ELT-36	5 - 16 bar (1/4" - 7/16")	1	

KUYU TİPİ SEVİYE ELEKTROTU



ÜRÜN KODU	AÇIKLAMALAR	KOLİ ADEDİ	₺ / ADET
ELT-E	Kuyu tipi elektrot	25	Fiyat Sorunuz

TTR KABLOLU SEVİYE FLATÖRÜ

ÜRÜN KODU	AÇIKLAMALAR	KUTU AD.	KOLİ AD.	₺ / ADET
FT-160	1,60 mt. TTR Seviye Flatörü	1	30	Fiyat Sorunuz
FT-300	3 mt. TTR Seviye Flatörü	1	30	
FT-500	5 mt. TTR Seviye Flatörü	1	30	
FT-1000	10 mt. TTR Seviye Flatörü	1	15	
FT-1500	15 mt. TTR Seviye Flatörü	1	15	

KAUÇUK KABLOLU SEVİYE FLATÖRÜ

ÜRÜN KODU	AÇIKLAMALAR	KUTU AD.	KOLİ AD.	₺ / ADET
FT-160K	1,60 mt. Kauçuk Seviye Flatörü	1	30	Fiyat Sorunuz
FT-300K	3 mt. Kauçuk Seviye Flatörü	1	30	
FT-500K	5 mt. Kauçuk Seviye Flatörü	1	30	
FT-1000K	10 mt. Kauçuk Seviye Flatörü	1	15	
FT-1500K	15 mt. Kauçuk Seviye Flatörü	1	15	

90° AÇILI ÇALIŞAN ATIK SIVI SEVİYE FLATÖRÜ

ÜRÜN KODU	AÇIKLAMALAR	KUTU AD.	KOLİ AD.	₺ / ADET
FT-300A	3 mt. Kauçuk Atık Sıvı Seviye Flatörü	1	25	Fiyat Sorunuz
FT-500A	5 mt. Kauçuk Atık Sıvı Seviye Flatörü	1	20	
FT-1000A	10 mt. Kauçuk Atık Sıvı Seviye Flatörü	1	15	
FT-1500A	15 mt. Kauçuk Atık Sıvı Seviye Flatörü	1	15	
FT-2000A	20 mt. Kauçuk Atık Sıvı Seviye Flatörü	1	10	

40° AÇILI ÇALIŞAN ATIK SIVI SEVİYE FLATÖRÜ

ÜRÜN KODU	AÇIKLAMALAR	KUTU AD.	KOLİ AD.	₺ / ADET
FT-300B	3 mt. Kauçuk Atık Sıvı Seviye Flatörü	1	25	Fiyat Sorunuz
FT-500B	5 mt. Kauçuk Atık Sıvı Seviye Flatörü	1	20	
FT-1000B	10 mt. Kauçuk Atık Sıvı Seviye Flatörü	1	15	
FT-1500B	15 mt. Kauçuk Atık Sıvı Seviye Flatörü	1	15	
FT-2000B	20 mt. Kauçuk Atık Sıvı Seviye Flatörü	1	10	

DALGIÇ POMPA KAUÇUK SEVİYE FLATÖRÜ

ÜRÜN KODU	AÇIKLAMALAR	KUTU AD.	KOLİ AD.	₺ / ADET
FT-60K1	0,60 mt. Kauçuk 2x1 mm 7,8 mm H05-RNF	1	25	Fiyat Sorunuz
FT-60K2	0,60 mt. Kauçuk 2x1 mm 9,0 mm H07-RNF	1	20	

BAKIR İLETKENLER İÇİN REÇİNELİ KABLO EK MUFLARI (0.6 - 1 kV)



ŞEFFAF REÇİNELİ KABLO EK MUFLARI (0.6 - 1 kV)



PROTOLİNLER / REÇİNELER



A.G. PABUÇLU REÇ. KAB. BAŞLIKLARI (0.6 - 1 kV)



O.G. 3 DAMARLI HARİCİ İSİ BÜZ. KAB. BAŞ. (20.8-36 kV)



FERMUARLI İSİ BÜZ. KAB. EK MUF (0.6 - 1 kV)



PLASTİK HUNİ KALIPLARI



BAKIR İLETKENLER İÇİN İSİ BÜZÜŞMELİ KABLO EK MUFLARI (0.6 - 1 kV)



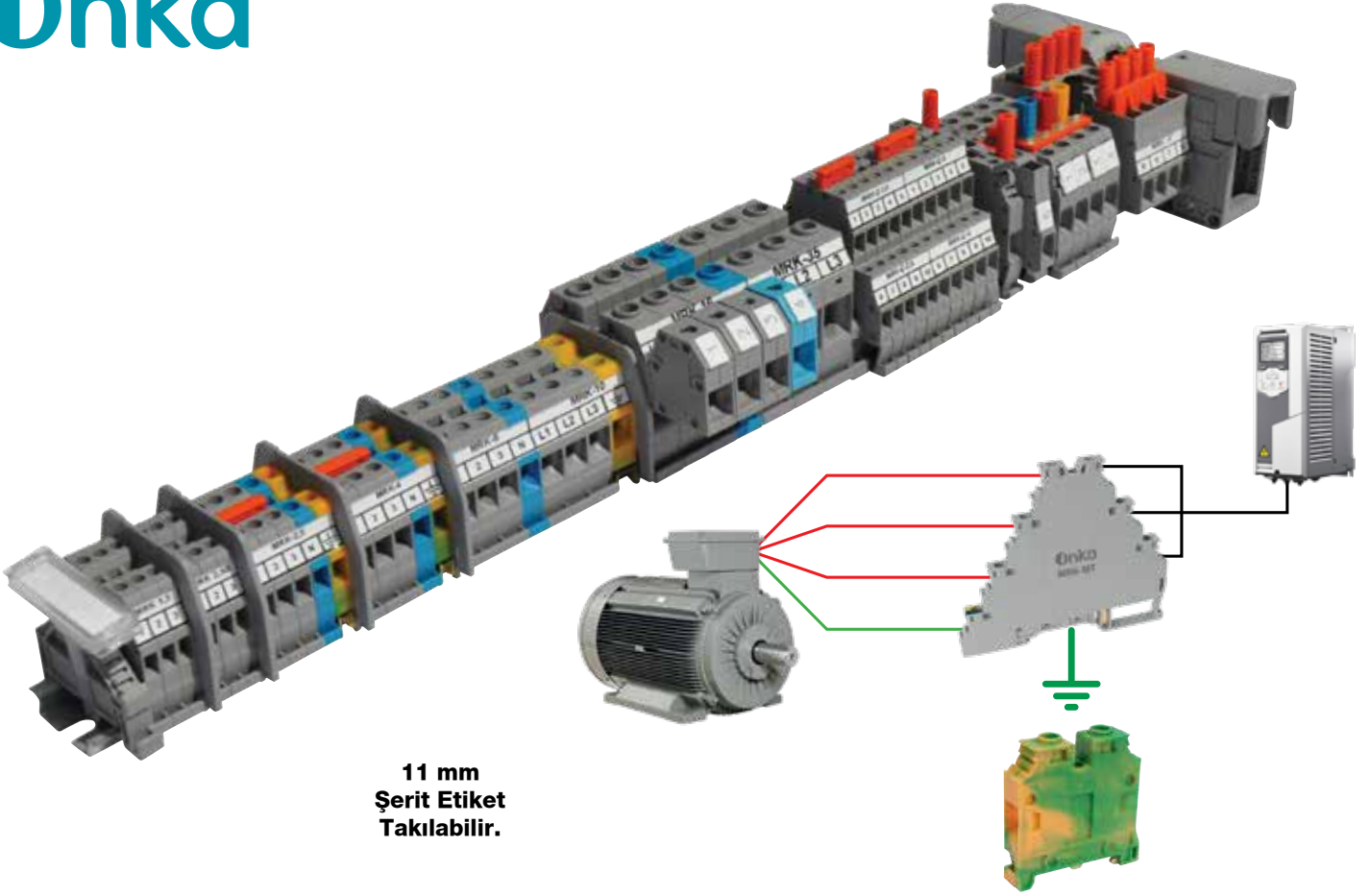

**11 mm
Şerit Etiket
Takılabilir.**

Vida Bağlantılı Ray Klemensler

MRK SERİSİ

- Nihayet plakası gerektirmez. (Her iki tarafı kapalı)
- Daha iyi bir izolasyon ve maliyet avantajı sağlar.
- Simetrik. (Her iki yönde raya monte edilebilir)
- 0,25 mm² den 240 mm² kablo kesimine kadar montaj imkanı sağlar.
- Renk Kodlama / Dekafix / Şerit Etiketleme olanaklarıyla evrensel markalama avantajları
- Çift yönlü köprüleme imkanı.
- 1,5 mm² den 10 mm² ye kadar izoleli tarak köprü kullanılabilir.
- Vida sistemi 1,5 mm² den 35 mm² ye kadar düz başlı, 50 mm² ve sonraki kesitlerde alyan başlıdır.
- Ergonomik ve kompakt tasarımlara imkan sağlayarak montaj alanını minimize eder.
- MRK Serisi 1.5-2.5-4-6-10-16-25-35-50-70-95-120 mm² kesitlerde üretilmektedir.
- Klemens içerisindeki bakır bara ve kovan iç çerçevesinde yapılan setler, montajı tamamlanan iletken üzerinde maksimum güvenli bağlantı sağlar.
- MRK 16, 25 ve 35'in köprüleme sistemi vidalı üst köprüdür.



Onka®

PUSH IN

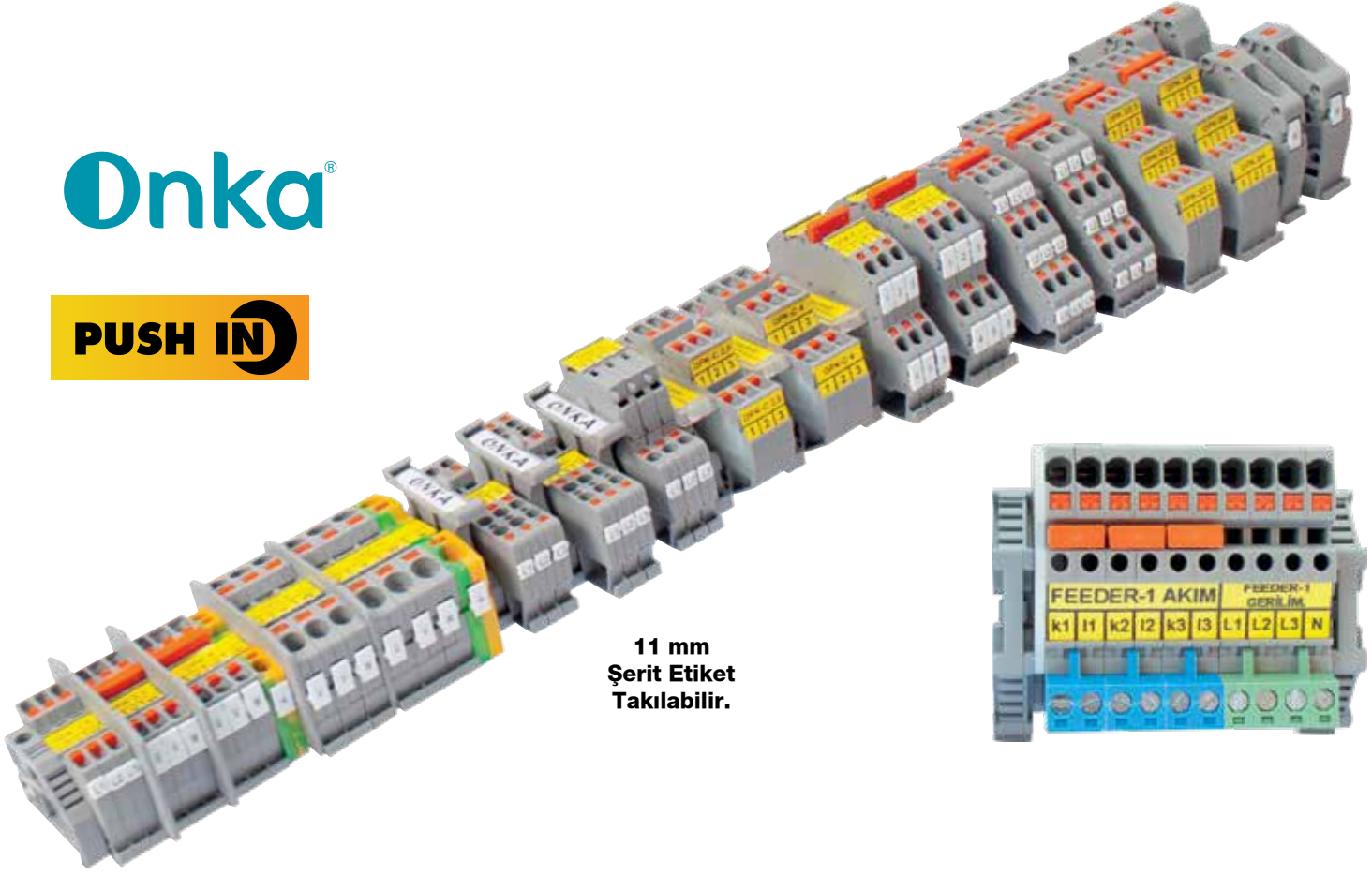

11 mm
Şerit Etiket
Takılabilir.



OPK SERİSİ

Yay Bağlantılı Ray Klemensler

- Push-in Sistem.
- Nihayet plakası gerektirmez. (Her iki tarafı kapalı)
- Daha iyi bir izolasyon ve maliyet avantajı sağlar.
- 1 Katlılar simetrikler. (Her iki yönde raya monte edilebilir)
- Daha düşük kablo itme kuvvetiyle kolay montaj.
- Zaman ve maliyet tasarrufu.
- Yalıtkan butonlar sayesinde montaj esnasında iletken kısma sıfır temas.
- Paslanmaz çelik itici yaylar.
- 0,25 mm² 'den 35 mm² 'ye kadar yüksüklü kablolarda el aleti gerektirmeden montaj imkanı.
- Renk Kodlama / Dekafix / Şerit Etiketleme olanaklarıyla evrensel markalama avantajları

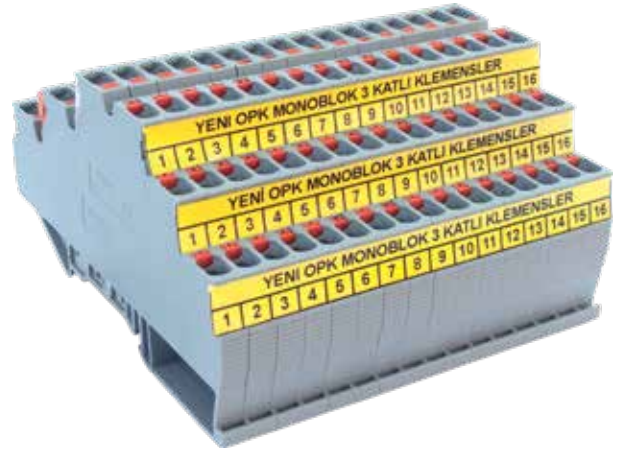

SOLMAZSAN®

ONKA yetkili SATICISIDIR
Geçerli listeden iskonto sorunuz.



Çetinkaya Pano yetkili SATICISIDIR
Geçerli listeden iskonto sorunuz.



NOTLAR

A series of horizontal dotted lines for writing notes.

SOLMAZSAN®



Perpa Ticaret Merkezi A Blok
Kat: 4-5 No: 215 Okmeydanı / İstanbul
Tel: 0212 222 65 70 Fax: 0212 222 65 80
E-mail: info@solmazsan.com.tr
www.solmazsan.com.tr